







































Contents

COLLECTION	PAGE	IP65		COLLECTION	PAGE	IP65		COLLECTION	PAGE	IP65	
	Aubanne	158			Duo	174			Louis Philippe 1	206	
	Avenue 2	256			Equix	112	•		Louis Philippe 2	210	
	Avenue 3	262			Faktory	88			Louis Philippe 7	214	
	Avenue 4	268	•		Grumo	96	•		Louis XIII	280	
	Bamboo	136	•		Hector	26	•		Louvre	222	•
	Belcour	152			Hogar	16	•		Mona	108	•
	Bermude	140			Hugy	92	•		Monaco	202	
	Boléro	170			Ibuk	130	•		Montana	144	
	Boréal	194			Kent	100			Moon	188	
	Brick²	38			Kerlouan	148			Newpark	164	
	Chenonceau	228			Klint	68	•		OL11	120	•
	Citadelle	286	•		La Hutte	22	•		OL33	124	•
	Cooper	74	•		Lampiok 1	46	•		Phoros	198	
	Dallas	178			Lampiok 2	52	•		Place des Vosges 1 Évolution	238	•
					Lampiok 4	58	•		Place des Vosges 1 Tradition	232	
									Place des Vosges 2	244	
									Place des Vosges 3	250	
									RP195	84	•
									Séléné	80	•
									Sherlock	104	•
									Square	116	•
									Tank	64	•
									Tetra	32	•
									Trophy	184	
									Victoria	274	
									Vieille France	218	
									Technical Specifications	292	
									Size of lanterns		
									Photosensors		
									Sockets		
									Commitment against light pollution		
									Compliance with PRM Standards		
									Accessories		
									Ingress Protection (IP) ratings		
									Informations		
									Colour chart		

Collections

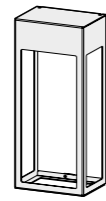

Hogar
p. 16

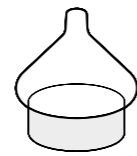

La Hutte
p. 22

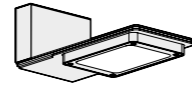

Hector
p. 26



Tetra
p. 32

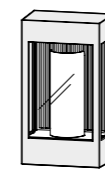

Brick²
p. 38

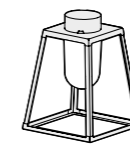

Lampiok 1
p. 46

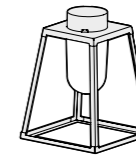

Lampiok 2
p. 52

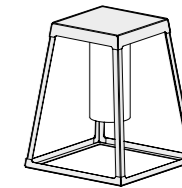

Lampiok 4
p. 58

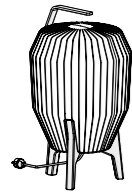

Tank
p. 64

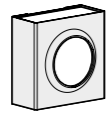

Klint
p. 68

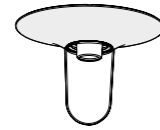

Copper
p. 74

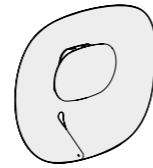

Séléne
p. 80

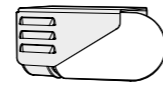

RP195
p. 84

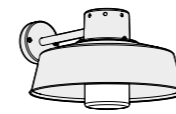

Faktory
p. 88

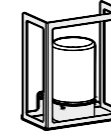

Hugy
p. 92



Grumo
p. 96

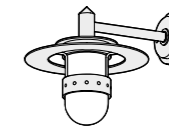

Kent
p. 100



Sherlock
p. 104



Mona
p. 108

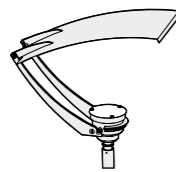

Equix
p. 112

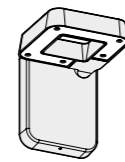

Square
p. 116

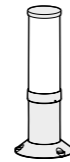

OL11
p. 120



OL33
p. 124



Ibuk
p. 130

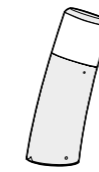

Bamboo
p. 136

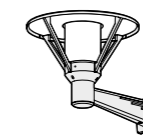

Bermude
p. 140

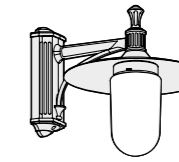

Montana
p. 144

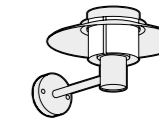

Kerlouan
p. 148

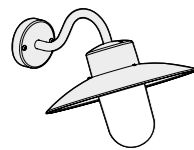

Belcour
p. 152

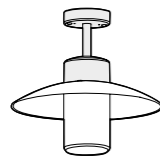

Aubanne
p. 158



Newpark
p. 164

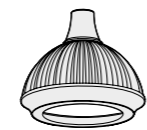

Boléro
p. 170

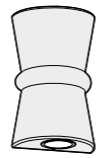

Duo
p. 174

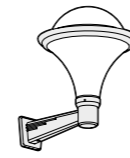

Dallas
p. 178



Trophy
p. 184

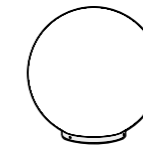

Moon
p. 188

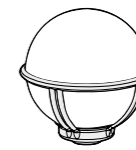

Boréal
p. 194



Phoros
p. 198



Monaco
p. 202



Louis Philippe 1
p. 206

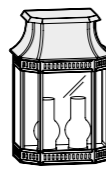

Louis Philippe 2
p. 210



Louis Philippe 7
p. 214



Vieille France
p. 218



Louvre
p. 222



Chenonceau
p. 228



Place des Vosges 1
Tradition
p. 232



Place des Vosges 1
Évolution
p. 238



Place des Vosges 2
p. 244



Place des Vosges 3
p. 250



Avenue 2
p. 256



Avenue 3
p. 262



Avenue 4
p. 268



Victoria
p. 274



Louis XIII
p. 280



Citadelle
p. 286

Editorial

Faithful to its tradition spanning more than 100 years, Roger Pradier® continues to work with unrelenting passion and dedication to light up your everyday outside spaces. Our outstanding know-how in the production of outdoor lighting is widely recognised and has earned us an “Entreprise du Patrimoine Vivant” mark from the French State. We are all very proud to belong to this select fraternity of manufacturers of products of the highest quality and we are thoroughly convinced that our continued mastery over our production processes is the key to our future.

Our stringent quality standards for our lighting products are our answer to the challenges of tomorrow, with timelessness of designs and durability of products fast becoming a necessity in a world that must transition towards greater sustainability. Local production is also a key aspect, with proximity and short supply chains among the best ways of significantly limiting our impact on the environment. Roger Pradier® continues to follow this approach, with the inauguration of a new extension of our Châteauroux factory that will feature a “zero defect” painting facility among other things.

In 2022 we also plan to make it possible for customers to order our lighting products online directly from the roger-pradier.com web site. This scheme that we are implementing for mainland France puts our partner stores at the very heart of the e-commerce process, which we want to make as hands-on as possible; customers will thus be able to collect their orders from the partner stores, and Roger Pradier® will continue to recommend that you go talk to them so as to jointly find the best solution to your projects.

In order to underpin our plans for growth, we will be expanding our team once again through the creation of new roles in our organisation. Jean-Michel Vergain will thus be joining us as Managing Director. We are delighted to welcome him and look forward to pursuing our journey together with him, and with you!

Tristan De Witte - *CEO*

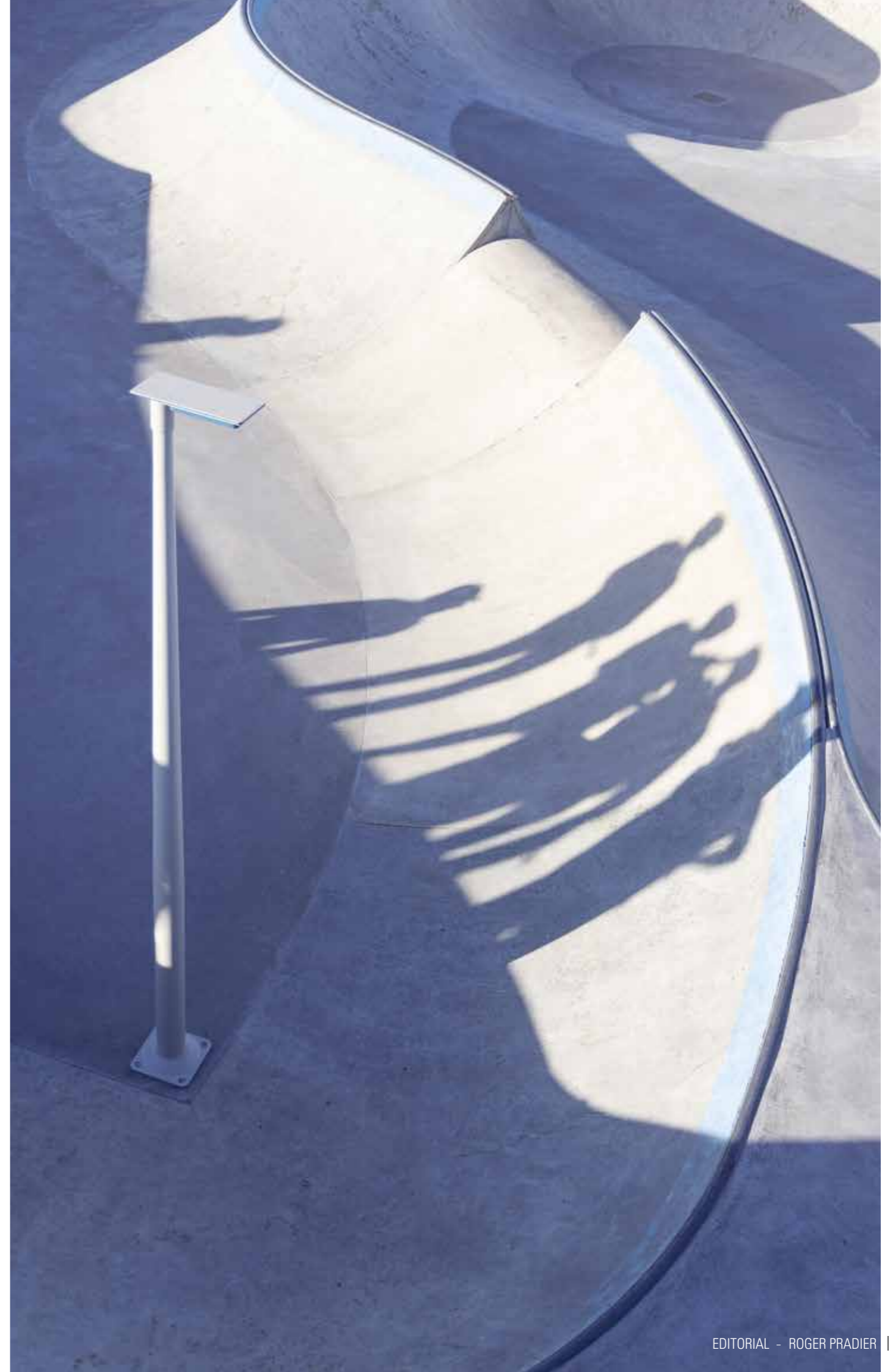

Know-how

- Research
- Creation
- Innovation
- Design
- Manufacturing
- Development
- Testing
- Tooling
- Bending
- Stamping
- Metal spinning
- Welding
- Surface treatment
- Painting
- Assembly
- Electrification assembly
- Shipping
- After-sales service
- Advice
- Tailor-made
- Lighting design



The team



Amandine. Sales Assistant - France

Anne-Claire. Industrial Designer

Aurélien. IT Manager

Benjamin. Sales Manager - France

Bertrand. Industrial Designer

Carole. Assembly Operator

Cécile. Sales Manager - Ile-de-France Area France

Chamouini. Welder

Christelle. Assembly Operator

Christiane. Assembly Operator

Christine. Surface Treatment Manager

Christine. Sales Manager - Southern Area France

Christophe. Sales Manager - Central & Southwestern Area France

Claudie. Assembly Operator

Denis. Project Manager - Design Office

Denis. Assembly Operator

Edith. QHSE Manager

Elena. Area Sales Manager - Iberian Peninsula

Eric. Industrial Tooling and Metalworking Manager

Fabien. Order Picker

Fleur. Export Sales Assistant

Florent. Area Sales Manager - Belgium Luxembourg

Frédéric. Maintenance Manager

Imanol. Area Sales Manager - South Germany

Isabelle. Assembly Operator

Jean-Luc. Sales Manager - Northeastern Area France

Jean-Michel. Managing Director

Jérôme. Surface Treatment Operator

Johann. Surface Treatment Operator

Julie. Assembly Operator

Julie. Spot Welding Machine Operator

Julien. Sales Manager - Rhône-Alpes Area France

Kristell. Administrative & Financial Director

Laurence. Assembly Manager

Léa. QHSE Assistant

Lionel. Forklift driver & Receiving Clerk

Manon. Accountant

Marie. Communication Manager

Marie-Véronique. Sales Assistant - France

Marjorie. Assembly Operator

Mathilde. Sales Assistant - France

Maud. Sales Assistant - France

Nadhir. Supplier

Nathalie. Assembly Operator

Nathalie. Spot Welding Machine Operator

Patrice. Design Production Manager

Philippe. Sales Manager - West Area France

Philippe. Welder

Roland. Press Machine Operator

Romain. Financial Controller Manager

Romain. Industrial Development Operator

Sabrina. Accountant

Salomé. Graphic Designer

Sébastien. Lean Management Manager

Sébastien. Press Machine Operator

Sophie. Sales Assistant - France

Sophie. Plant Manager

Stéphane. Creative Director

Stéphane. Sales Director - France

Stéphanie. Export Sales Assistant

Sylvie. Assembly Operator

Théo. IT Assistant

Thibaud. Export Sales Manager

Thierry. Technical Director & Industrial Development

Tristan. CEO

Valentin. Area Sales Manager - Sweden

Yohan. Surface Treatment Operator

Yvan. Industrial Designer

Designers



© Arnaud Childeric

Stéphane Joyeux

Creative Director of Roger Pradier® since 2001, Stéphane Joyeux holds a diploma from the Creapole-Esdi Design School.

With a solid grounding in every stage of the industrial design process – research, dimensional modelling, prototype testing – he’s an expert at developing technical solutions. He has undertaken collaborative gigs in the automotive, sports and electrical industries with the likes of Plasto Design, Salomon, and Arnould, so his intuitive approach is informed by additional know-how specific to these fields. It was Stéphane who launched Roger Pradier®’s contemporary ranges of outdoor lighting. Taking the helm of the entire design process, he does his share of sketching and modelling, and provides creative oversight every step of the way.

Excellence and utility are his watchwords. He enjoys balancing ingenuity with design to address the ethical, environmental and sustainability issues inherent in lighting engineering. For Stéphane, every lamp represents an aesthetic challenge, embodying his personal commitment to design first-rate products that meet today’s standards on criteria like energy efficiency and longevity.

He’s known for the innovative form and playful feel of his lighting fixtures, including Equix, Grumo, Brick, Bamboo, Sherlock, RP195, and the Ibuk wall light, which won the 2015 VIA Award for its originality. His design approach interweaves childhood memories and innovation with technical understanding, so that after the initial surprise, you see that utility is the only remaining reason...

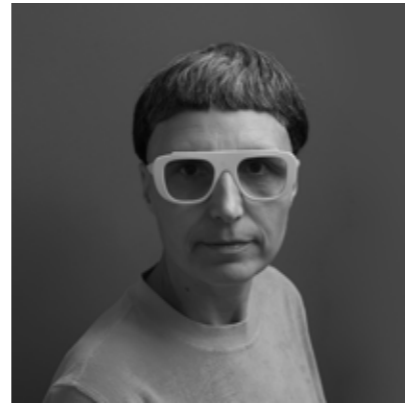

© Julien Jouanjus

matali crasset

La Hutte

matali crasset, an industrial designer by training, experiences design as a form of seeking. The offbeat stance she takes as her starting point informs her interventions in the everyday, and prompts imagined scenarios for the future.

Her knowledgeable – yet always fresh – worldview leads her to question the unassailable nature of conventions, all the better to break free of them. She operates in many spheres, her interventions always linked to her encounters. Eclectic collaborations – from handicrafts to contemporary art, from the textile industry to fair trade – have led to her working in scenography, furniture, architecture, graphic design and art. So far, her associates on various projects include artist Peter Halley, up-and-coming designer furniture companies, local authorities (Geneva Cité Library, the town of Istres) and local communities.

With this wealth of creative practice under her belt, matali is now veering towards increasingly participative projects, working at both local and global scale, and in rural as well as urban settings.

Her fictional inventions, her narratives, and the meaning of her work are essentially bound up with the question of community and living together.



© Dimitri Coste

Patrick Norguet

Square

French industrial designer Patrick Norguet has taken an unusual career path in his pursuit of the flawless line. He’s well known among the big names of high-end designer furniture, both in France and internationally. A fateful meeting with Giulio Cappellini in 1999 and the subsequent release of his famous Rainbow Chair propelled Patrick into the top ranks of the design elite.

There’s a very French elegance and ‘fittingness’ about his pieces, whether they’re intended for the masses or a more upscale market.

Norguet’s work has won a long string of awards, along with a place in the permanent collection of New York’s MoMA and in the Museum of Modern Art in Miami.

In creating his timeless, beautifully balanced objects, he draws inspiration from the world around him, and from the generous spirit of people he meets.



© Morgane Le Gall

Normal Studio

Séléné

Working together as Normal Studio, design duo Jean-François Dingjian and Eloi Chafaï promote a kind of design stripped back to its most fundamental. Their name dissimulates a yearning for perfect form. The timeless objects they produce fly in the face of fashion and posturing, reflecting their strong belief in the social and cultural values of design.

By 2016 when Normal Studio celebrated its first decade on the French scene, it already had a pile of accolades to its name. The Design/Enterprise award at Designers’ Day 2010 honoured the team’s collaboration with Tolix, where they were creative directors from 2007 to 2013. They won 2010 Designer of the Year at Maison & Objet’s Now! Show, followed by the Elle Deco Design Award, and numerous VIA labels. Some of their products are now held in the collections of the French Museum of Decorative Arts and the Fonds National d’Art Contemporain (France’s state-owned contemporary art collection).

Normal Studio designed Séléné for Roger Pradier®, a range that was awarded the 2011 VIA Label.



© Tristan Everhard

Cédric Ragot

Tank

A multi-talented French designer influenced by contemporary art, Cédric Ragot has marked the design world with the sensitive, intuitive aesthetics of his sober objects.

This prolific designer set up Cédric Ragot Design Studio in 2002 to work alongside big-name brands on development and positioning.

A very intuitive designer, Ragot has been recognised with numerous accolades.

Some of his pieces are in the Fonds National d’Art Contemporain and on display in Paris, Hannover, Vienna, New York, or Milan.

With his latest design, Tank, he leaves the abiding imprint of his talent on Roger Pradier®.

Roger Pradier® warranties



25 year anti-corrosion warranty

The Roger Pradier® company commits itself to replace any faulty part that shows sign of corrosion in a period of 25 years from the date of acquisition by the final client, upon presentation of the purchase invoice.

The guarantee applies only to the aluminium part of Roger Pradier® products installed above ground in accordance with industry standards and with the original surface treatment being intact.

Exclusions: products that are scratched, scored, covered with silicone, cement, or any other material, or that have suffered collision or various chemical treatments. This guarantee also excludes any phenomenon that may modify the aspect of the covering over time, natural dirt, deposits of all types, etc. ...

The warranty requires the product(s) to be returned to the factory. No exchange prior to that return can be considered. Roger Pradier® will only replace the damaged part and not the whole appliance; transport, dismantling and installation costs are excluded.

The Roger Pradier® company reserves the right to analyse or to have analysed, by any method of its choice, the damage caused by corrosion, in order to determine the reliability and the conditions of the said damage. In any event, this guarantee does not apply to the various electrical components and accessories of the product.

5 year technical warranty

Other than the specific 25 year anti-corrosion warranty, Roger Pradier® products are guaranteed for 5-years. The technical warranty covers over a 5-years period from the date from the acquisition date by the final client, upon presentation of the purchase receipt. This warranty shall only apply to products installed according to current practice and which are used in conformance with our recommendations. Any intervention or modification made to the product and its components is expressly excluded from this warranty.

The warranty requires the product(s) to be returned to the factory. No exchange prior to that return can be considered. Roger Pradier® will only replace the affected component(s) and not the whole appliance; transport, dismantling and installation costs are excluded.

Roger Pradier®'s sales commitment

- A century's worth of experience as a French manufacturer of outdoor lighting devices
- Widely acknowledged expertise
- A culture of quality
- External inspections
- International certifications. Refer to the US catalogue for UL-certified references.

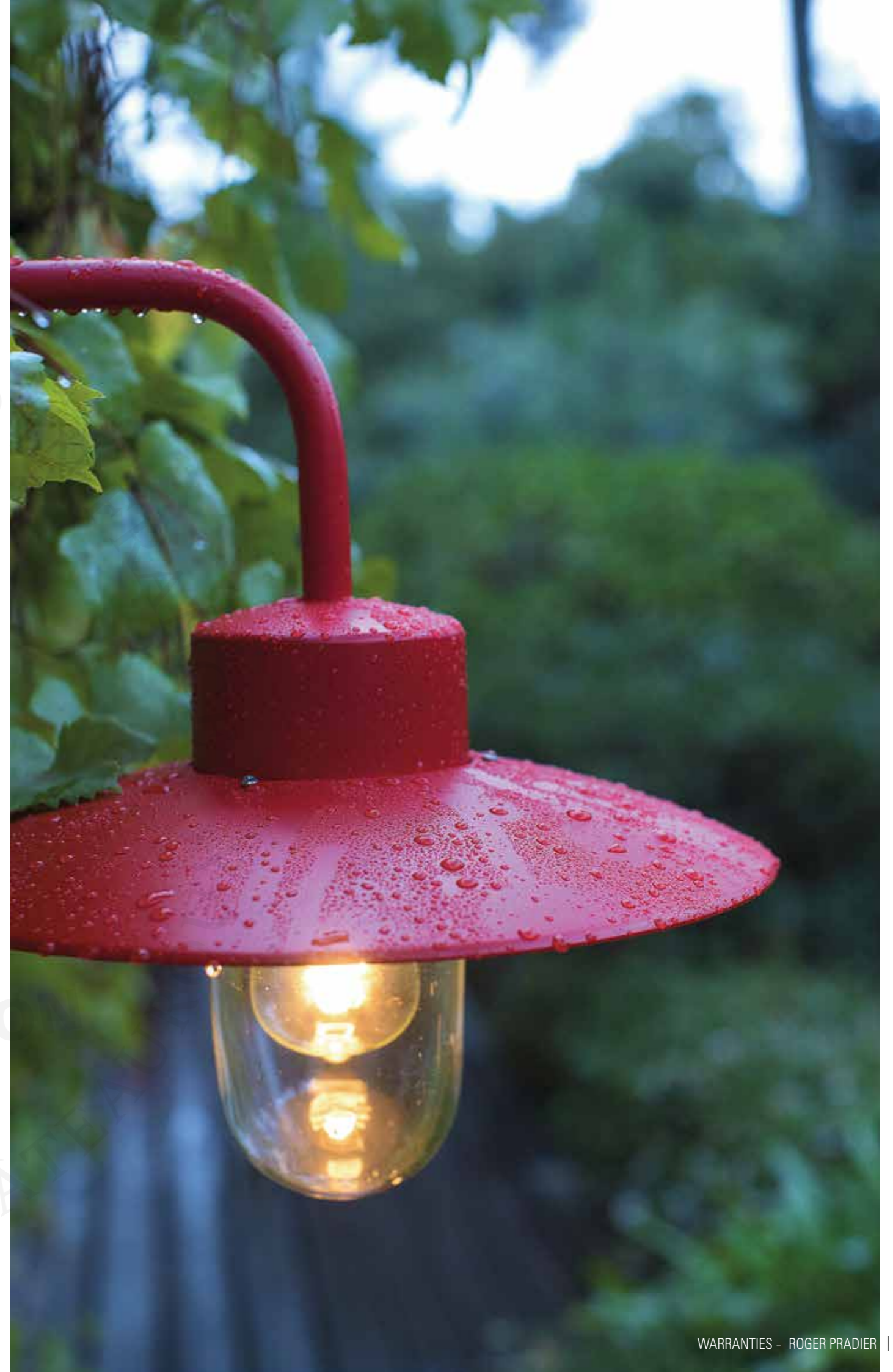

Hogar

Design Stéphane Joyeux

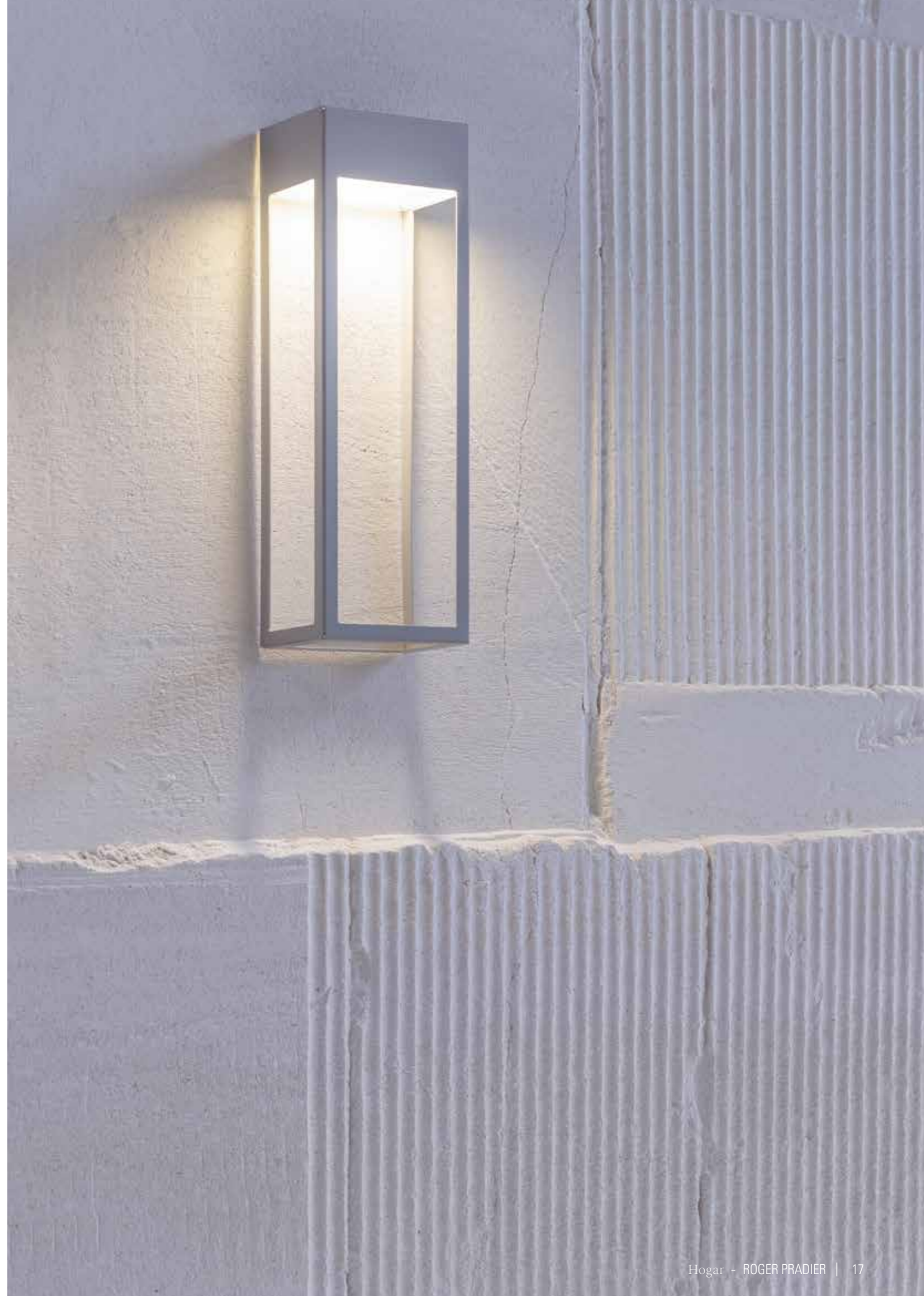



Hogar

Aluminium
Satin-finish PMMA diffuser
IP65 (LED module and driver) / IP44 (GU10) / IK10 / Class 1

SOURCES

LED 26W - 3000K warm white
LED 26W - 4000K neutral white
LED 35W - 1-10 Volt Dimmable - 3000K warm white
LED 35W - 1-10 Volt Dimmable - 4000K neutral white
LED 35W - DALI Dimmable - 3000K warm white
LED 35W - DALI Dimmable - 4000K neutral white
GU10 2x9W

H 600 mm
W 260 mm
D 183 mm

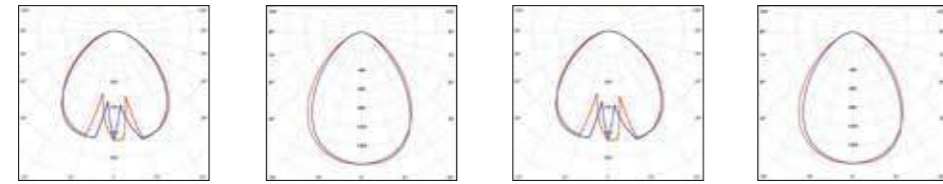
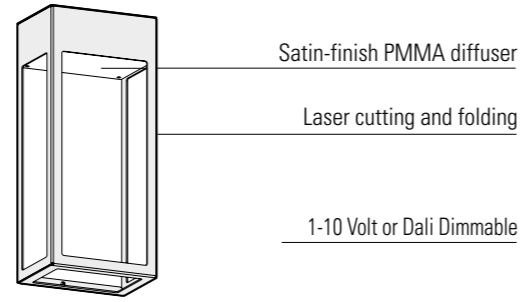

Models 1 to 3

LED 26W
Real light output - 1952 lm
CRI > 80

Model 4

LED 26W
Real light output - 2055 lm
CRI > 80

Models 1 to 3

LED 35W
Real light output - 2628 lm
CRI > 80

Model 4

LED 35W
Real light output - 2767 lm
CRI > 80

PRM Eav 20 lux p.304
Models 1 to 4

LED 35W	Pathway	Spacing
H 2,50 m	2,50 m	20,00 m

MODELS

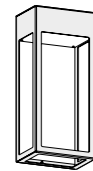

H600 . W260 . D183
1

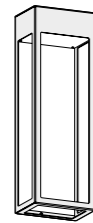

H800 . W260 . D183
2

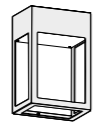

H400 . W260 . D183
3



H105 . W260 . D183
4



COLOURS CODES

Replace ●●● with the colour code

●●●	RAL 9005 JET BLACK	000
●●●	RAL 7021 BLACK GREY	107
●●●	RAL 7044 SILK GREY	105
●●●	RAL 9010 PURE WHITE	101
●●●	RAL 5011 STEEL BLUE	065
●●●	RAL 6025 FERN GREEN	109
●●●	RAL 3013 TOMATO RED	110
●●●	OLD RUSTIC	046

Other colours on request

MOUNTING

Wiring entry points in grey
Fixing kit included

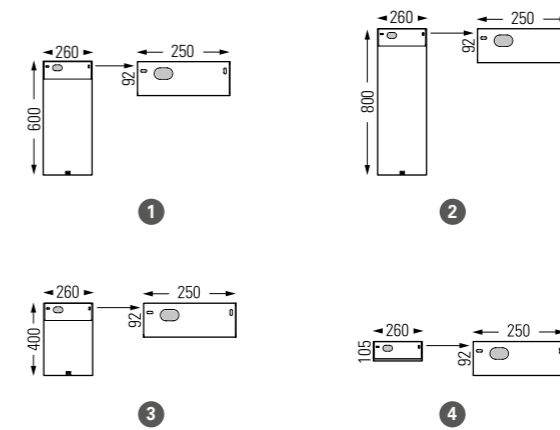

REFERENCES

Replace ●●● with the colour code

MODELS	GU10 2x9W	LED 26W 3000K warm white	LED 26W 4000K neutral white	LED 35W 3000K warm white 1-10 Volt Dimmable	LED 35W 4000K neutral white 1-10 Volt Dimmable	LED 35W 3000K warm white DALI Dimmable	LED 35W 4000K neutral white DALI Dimmable
1	177 058 ●●●	177 010 ●●●	177 012 ●●●	177 026 ●●●	177 028 ●●●	177 042 ●●●	177 044 ●●●
2	177 060 ●●●	177 014 ●●●	177 016 ●●●	177 030 ●●●	177 032 ●●●	177 046 ●●●	177 048 ●●●
3	177 062 ●●●	177 018 ●●●	177 020 ●●●	177 034 ●●●	177 036 ●●●	177 050 ●●●	177 052 ●●●
4	177 064 ●●●	177 022 ●●●	177 024 ●●●	177 038 ●●●	177 040 ●●●	177 054 ●●●	177 056 ●●●

SPARE DIFFUSER

165 090 616

Hogar

La Hutte

Design matali crasset

The "La Hutte" lamp draws inspiration from the shape of a primitive hut, a circular shelter built around the fire that was essential to life.

Its protective glass casing is like the walls of a house, storing and then releasing photons. "La Hutte" is a shelter, a kindly presence that reproduces the warmth and light of a home fire.

The lamp consists of two elements: a metal base available in all colours, and a transparent blown glass upper. The design comes in three versions, either a table lamp, a model you can hang, or a floor lamp.



La Hutte

Aluminium
Clear glass diffuser
IP65 / Class 2

SOURCE

E27 - 23W max

MODELS

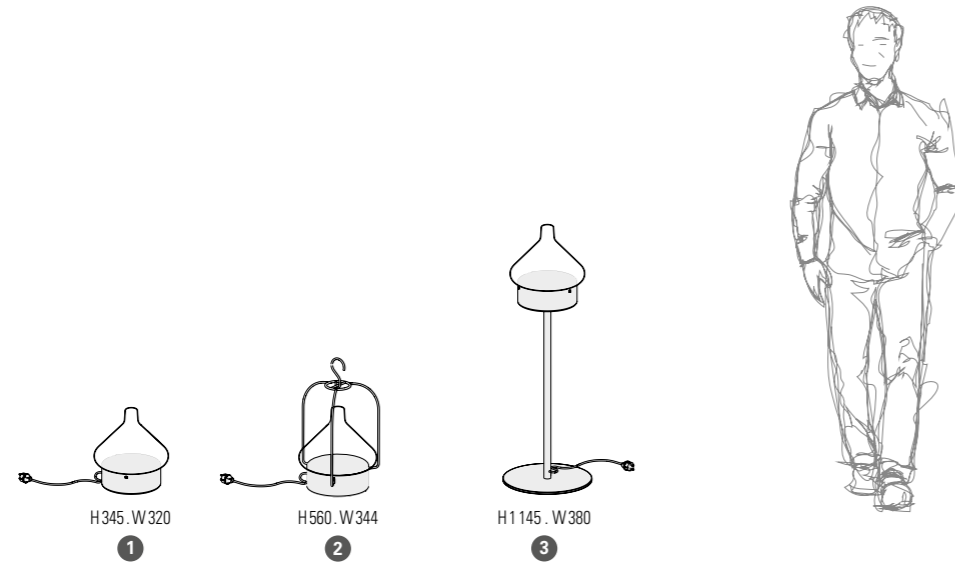
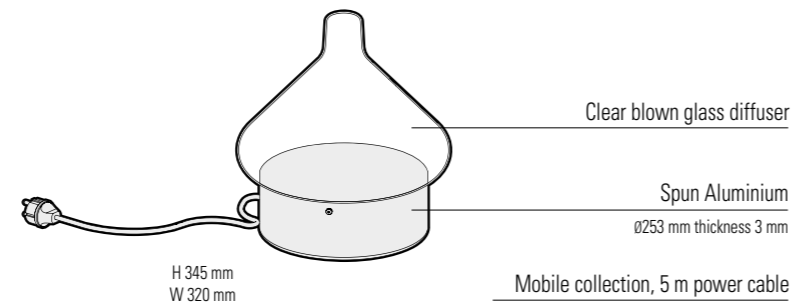

REFERENCES

Replace ●●● with the colour code / replace (●) with the country's electrical plug code

MODELS	E27
1	166 001 ●●● (●)
2	166 002 ●●● (●)
3	166 003 ●●● (●)
SPARE DIFFUSER	
165 085 609	

COLOURS CODES

Replace ●●● with the colour code ↴

	RAL 7021 BLACK GREY 107		RAL 3005 WINE RED 066
	RAL 9010 PURE WHITE 101		RAL 3013 TOMATO RED 110
	BLUE 111		RAL 2004 PURE ORANGE 014
Other colours on request			RAL 6025 FERN GREEN 109

PLUGS CODES

The standard Roger Pradier® plugs are SCHUKO plugs type F
Except for French plugs, replace (●) with the country's plug code ↴

	UK PLUG UK type G		SWISS PLUG CH type J
--	----------------------	--	-------------------------



Hector

Design Stéphane Joyeux



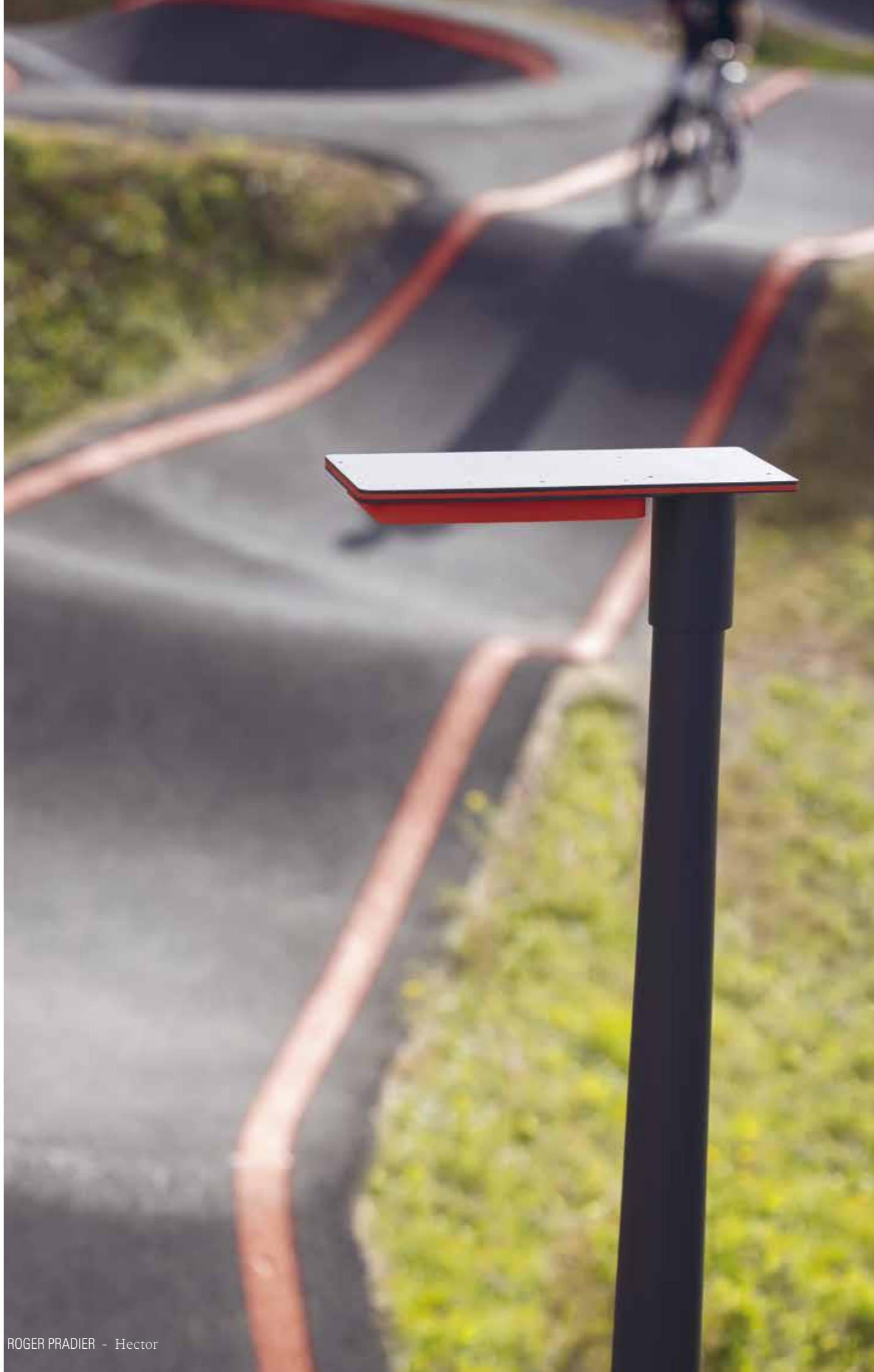

Exemple of specific colour (excluding Roger Pradier® colour chart) on request

Hector

Aluminium
Screen-printed clear glass diffuser
IP65 / Class 1

SOURCES

LED SYM 26W - 3000K warm white
LED ASYM 26W - 3000K warm white
LED SYM 35W - 1-10 Volt Dimmable - 3000K warm white
LED ASYM 35W - 1-10 Volt Dimmable - 3000K warm white
LED SYM 35W - DALI Dimmable - 3000K warm white
LED ASYM 35W - DALI Dimmable - 3000K warm white

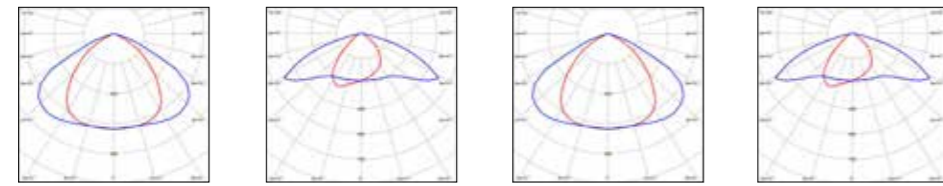

Models 1 to 3
LED 26W SYM
Real light output - 3250 lm
CRI > 80

Models 1 to 3
LED 26W ASYM
Real light output - 3270 lm
CRI > 80

Models 1 to 3
LED 35W SYM
Real light output - 4280 lm
CRI > 80

Models 1 to 3
LED 35W ASYM
Real light output - 4250 lm
CRI > 80

MODELS

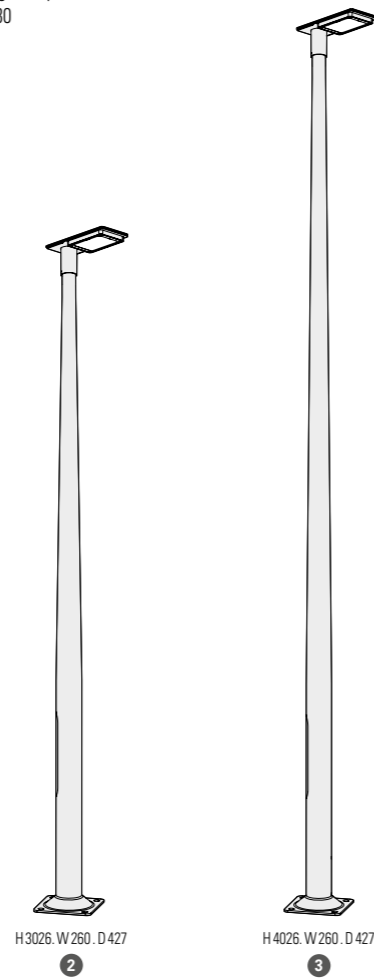

PRM Eav 20 lux p.304
Model 2 ASYM

LED ASYM 35W	Pathway	Spacing
H 3,00m	3,00m	25,00m

- 107
- 105
- 065
- 101
- 046

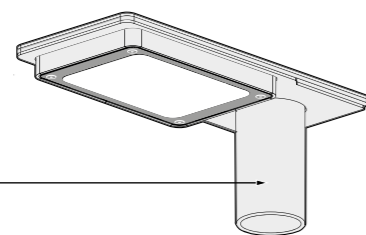

Single-colour version

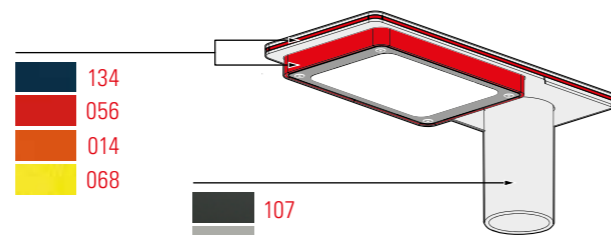

Two-colour version

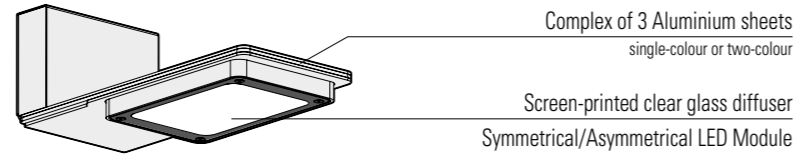

Available as a head only
with remote driver for installation on Ø60 pole

Hector

REFERENCES

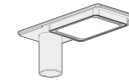

Single-colour version



Two-colour version
Silk grey 105 support



Two-colour version
Black grey 107 support

COLOURS CODES

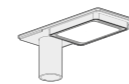

Single-colour version



Two-colour version
Silk grey 105 support
Black grey 107 support

Replace ●●● with the colour code

MODELS	LED SYMMETRIC			LED ASYMMETRIC		
	26W 3000K warm white	35W 3000K warm white 1-10 Volt Dimmable	35W 3000K warm white Dali Dimmable	26W 3000K warm white	35W 3000K warm white 1-10 Volt Dimmable	35W 3000K warm white Dali Dimmable
1	182 001 ●●●	182 003 ●●●	182 005 ●●●	182 002 ●●●	182 004 ●●●	182 006 ●●●
2	182 013 ●●●	182 015 ●●●	182 017 ●●●	182 014 ●●●	182 016 ●●●	182 018 ●●●
3	182 019 ●●●	182 021 ●●●	182 023 ●●●	182 020 ●●●	182 022 ●●●	182 024 ●●●

MODELS	LED SYMMETRIC			LED ASYMMETRIC		
	26W 3000K warm white	35W 3000K warm white 1-10 Volt Dimmable	35W 3000K warm white Dali Dimmable	26W 3000K warm white	35W 3000K warm white 1-10 Volt Dimmable	35W 3000K warm white Dali Dimmable
1	182 201 ●●●	182 203 ●●●	182 205 ●●●	182 202 ●●●	182 204 ●●●	182 206 ●●●
2	182 213 ●●●	182 215 ●●●	182 217 ●●●	182 214 ●●●	182 216 ●●●	182 218 ●●●
3	182 219 ●●●	182 221 ●●●	182 223 ●●●	182 220 ●●●	182 222 ●●●	182 224 ●●●

MODELS	LED SYMMETRIC			LED ASYMMETRIC		
	26W 3000K warm white	35W 3000K warm white 1-10 Volt Dimmable	35W 3000K warm white Dali Dimmable	26W 3000K warm white	35W 3000K warm white 1-10 Volt Dimmable	35W 3000K warm white Dali Dimmable
1	182 301 ●●●	182 303 ●●●	182 305 ●●●	182 302 ●●●	182 304 ●●●	182 306 ●●●
2	182 313 ●●●	182 315 ●●●	182 317 ●●●	182 314 ●●●	182 316 ●●●	182 318 ●●●
3	182 319 ●●●	182 321 ●●●	182 323 ●●●	182 320 ●●●	182 322 ●●●	182 324 ●●●

SPARE DIFFUSER

165 108 609

Replace ●●● with the colour code

- RAL 7021 BLACK GREY 107
- RAL 7044 SILK GREY 105
- RAL 5011 STEEL BLUE 065
- RAL 9010 PURE WHITE 101
- OLD RUSTIC 046

Other colours on request

- RAL 5009 MATTE AZURE BLUE 134
- RAL 3020 TRAFFIC RED 056
- RAL 2004 PURE ORANGE 014
- RAL 1016 SULFUR YELLOW 068

Other colours on request

Specific colour (excluding Roger Pradier® colour chart) on request

MOUNTING

Wiring entry points in grey
Fixing kit included (model 1 only)
Anchor bolts on request (models 2 and 3) p.306



Tetra

Design Stéphane Joyeux





Tetra

Aluminium
Clear polycarbonate diffuser
Stainless steel bulb cover (E27 version)
IP65 / IK10 / Class 1

LED (Securlite technology) - Symmetric or Asymmetric version (except models 1 and 5)
see p.304

SOURCES

LED 12W - 2700K warm white
E27 - 70W max Ø66 mm - H 175 mm max (with bulb cover)
Ø80 mm - H 180 mm max (with bulb cover)

H 300 mm
W 170 mm
D 116 mm

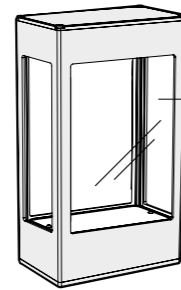

Extruded Aluminium profile

Clear polycarbonate diffuser

LED version
symmetric or asymmetric

E27 version
with stainless steel bulb cover

4-sided lighting

Ulor<1%

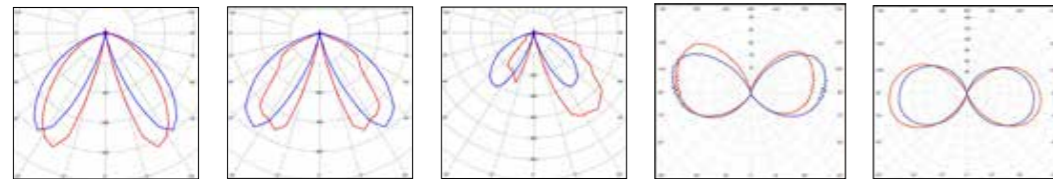

PRM Eav 20 lux p.304
Model 4 ASYM

LED 12W	Pathway	Spacing
H 1,10m	2,00m	12,00m

Models 1 and 5
LED 12W SYM
Real light output - 680 lm
CRI > 80

Models 2 to 4
LED 12W ASYM
Real light output - 797 lm
CRI > 80

Models 2 to 4
LED 12W ASYM
Real light output - 879 lm
CRI > 80

Models 1 to 5 with bulb cover
E27 (2450 lm)

Models 1 to 5 without bulb cover
E27 (2450 lm)
Real light output - 2129 lm

MODELS

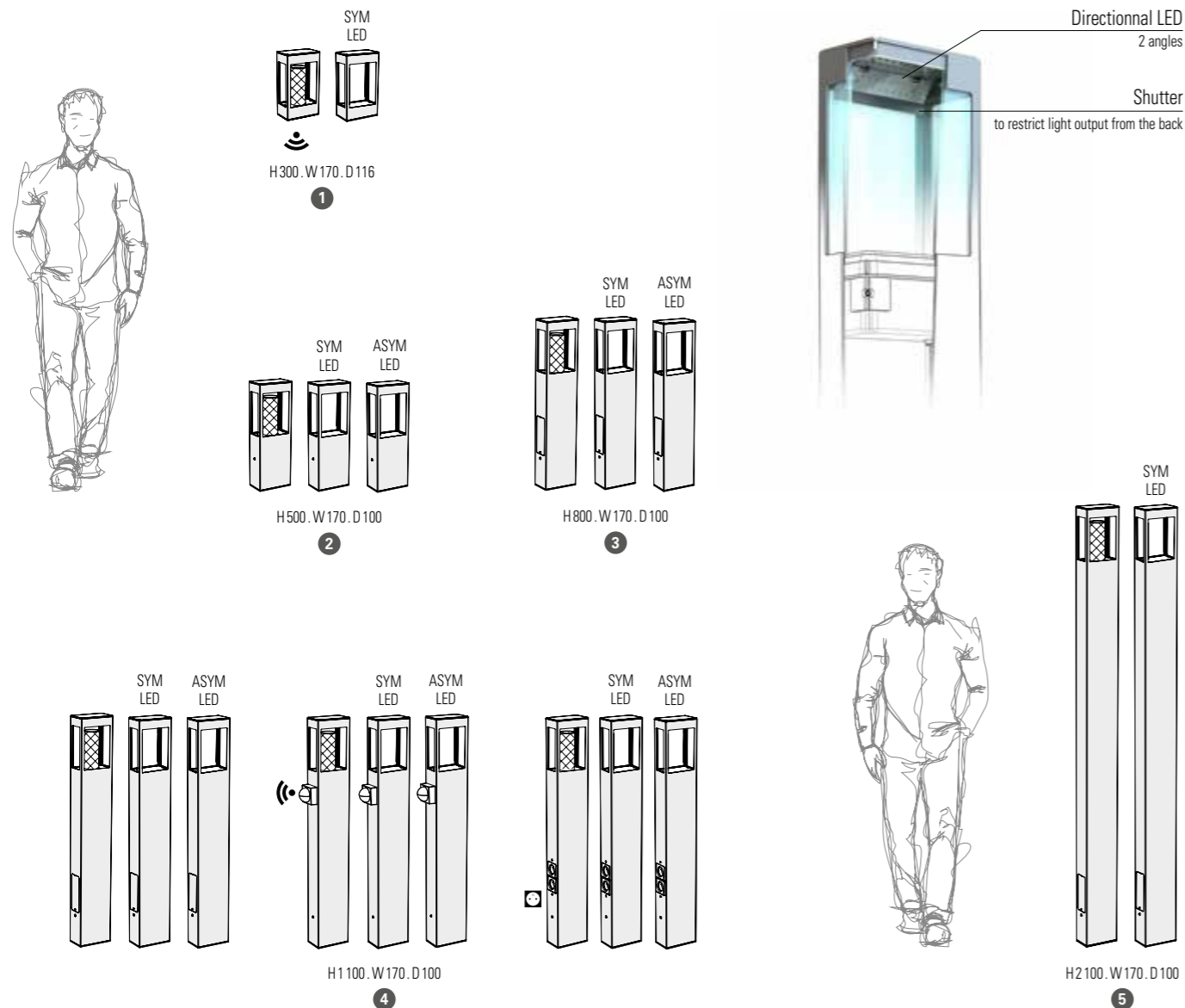

Tetra

REFERENCES

Replace ●●● with the colour code / replace (●) with the country's electrical socket code

MODELS	E27	LED SYMMETRIC 12W 2700K warm white	LED ASYMMETRIC 12W 2700K warm white
1	162 001 ●●●	162 306 ●●●	
2	162 007 ●●●	162 211 ●●●	162 111 ●●●
3	162 012 ●●●	162 216 ●●●	162 116 ●●●
4	162 017 ●●●	162 221 ●●●	162 121 ●●●
5	162 022 ●●●	162 326 ●●●	

☺ With sensor

MODELS	E27	LED SYMMETRIC 12W 2700K warm white	LED ASYMMETRIC 12W 2700K warm white
1	162 002 ●●●		
4	162 027 ●●●	162 229 ●●●	162 129 ●●●

🔌 With sockets

MODELS	E27	LED SYMMETRIC 12W 2700K warm white	LED ASYMMETRIC 12W 2700K warm white
4	162 031 ●●●(●)	162 233 ●●●(●)	162 133 ●●●(●)

SPARE DIFFUSER

165 066 601

SPARE BULB COVER (E27)

165 075 018

COLOURS CODES

Replace ●●● with the colour code

	RAL 9005 JET BLACK 000		RAL 5011 STEEL BLUE 065
	DARK GREY 006		RAL 3013 TOMATO RED 110
	METAL GREY 023		RAL 3020 TRAFFIC RED 056
	WHITE 001		OLD RUSTIC 046
	RAL 9010 PURE WHITE 101		RAL 6025 FERN GREEN 109

Other colours on request

SOCKETS CODES

Except for French socket, replace (●) with country's socket code

🔌 SCHUKO SOCKET SK type F SWISS SOCKET CH type J

MOUNTING

Wiring entry points in grey
Fixing kit included
Anchor bolts on request (model 5) p.306

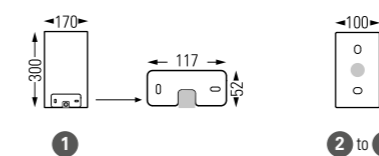

Brick²

Design Stéphane Joyeux







Aluminium
 Clear glass diffuser or black satin-finish PMMA diffuser
 Satin-finish polycarbonate bulb cover (model 1)
 or Satin-finish PMMA bulb cover (models 2 to 4)
 IP44 / Class 2

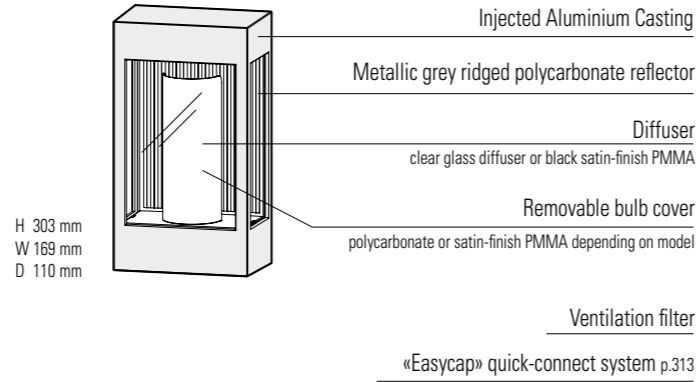

SOURCES

E27 - 23W max
 Ø67 mm - H 175 mm max (model 1 with bulb cover)
 Ø60 mm - H 180 mm max (models 2 to 4 with bulb cover)
 Ø80 mm - H 220 mm max (models 1 to 4 without bulb cover)

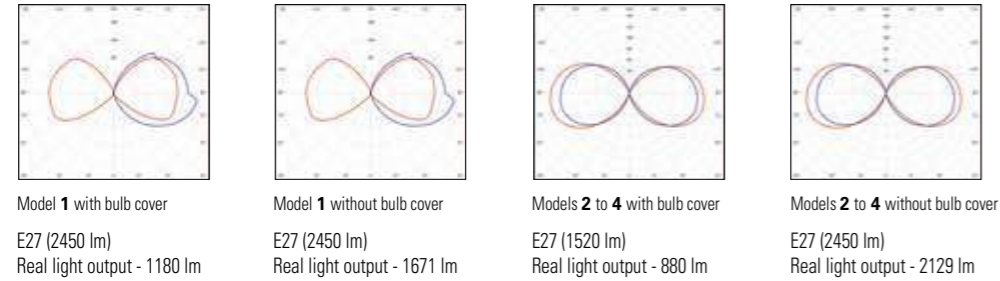

PRM Eav 20 lux p.304
 Model 3 without bulb cover

E27 (2450 lm)	Pathway	Spacing
H 0,80m	2,00m	8,00m

MODELS



H 303, W 169, D 110

1

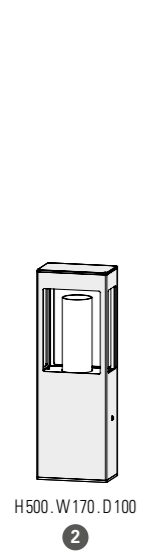

H 500, W 170, D 100

2

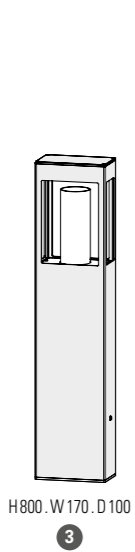

H 800, W 170, D 100

3

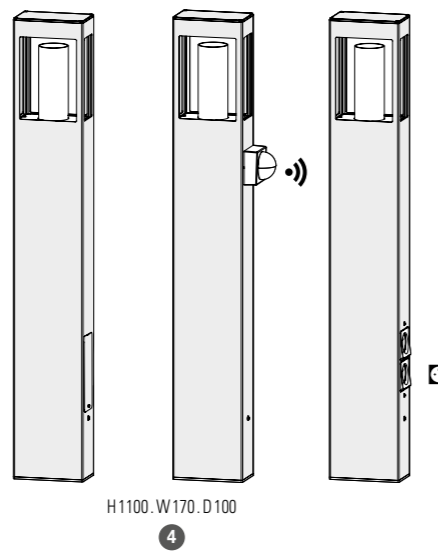

H 1100, W 170, D 100

4



REFERENCES

Replace ●●● with the colour code / replace (●) with the country's electrical socket code

MODELS	DIFFUSERS	E27	E27 + SENSOR	SOCKETS
1	CLEAR GLASS	108 001 ●●●		
	BLACK PMMA	108 004 ●●●		
2	CLEAR GLASS	108 002 ●●●		
	BLACK PMMA	108 005 ●●●		
3	CLEAR GLASS	108 003 ●●●		
	BLACK PMMA	108 006 ●●●		
4	CLEAR GLASS	108 007 ●●●	108 008 ●●●	108 009 ●●●(●)
	BLACK PMMA	108 010 ●●●	108 011 ●●●	108 012 ●●●(●)

SPARE DIFFUSERS

CLEAR GLASS (model 1)	165 013 609
CLEAR GLASS (models 2, 3 and 4)	165 014 609
BLACK PMMA (model 1)	165 013 617
BLACK PMMA (models 2, 3 and 4)	165 014 617

SPARE BULB COVERS

SATIN-FINISH POLYCARBONATE (model 1)	165 071 611
SATIN-FINISH PMMA (models 2, 3 and 4)	165 072 612

COLOURS CODES

Replace ●●● with the colour code

	VELVET BLACK 113		RAL 6025 FERN GREEN 109
	RAL 7021 BLACK GREY 107		DARK GREY 006
	RAL 7044 SILK GREY 105		SLATE GREY 059
	RAL 9010 PURE WHITE 101		WHITE 001
	RAL 5011 STEEL BLUE 065		BLUE 111
	RAL 3005 WINE RED 066		LIMESTONE 053
	RAL 3013 TOMATO RED 110		SANDSTONE 054
	RAL 3020 TRAFFIC RED 056		OLD RUSTIC 046
	RAL 2004 PURE ORANGE 014		RAW ALUMINIUM - MATTE VARNISH 129 model 1 only

Other colours on request

SOCKETS CODES

Except for French socket, replace (●) with country's socket code

	SCHUKO SOCKET SK type F		SWISS SOCKET CH type J
--	----------------------------	--	---------------------------

MOUNTING

Wiring entry points in grey
 Fixing kit included

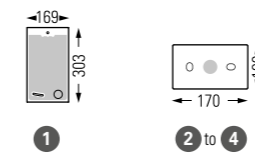

Lampiock 1

Design Stéphane Joyeux

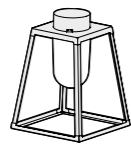

Lampiock 1

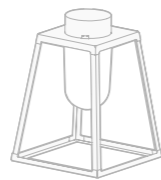

Lampiock 2

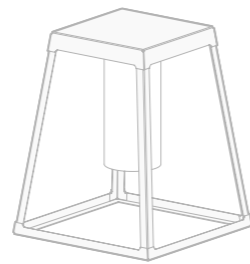

Lampiock 4

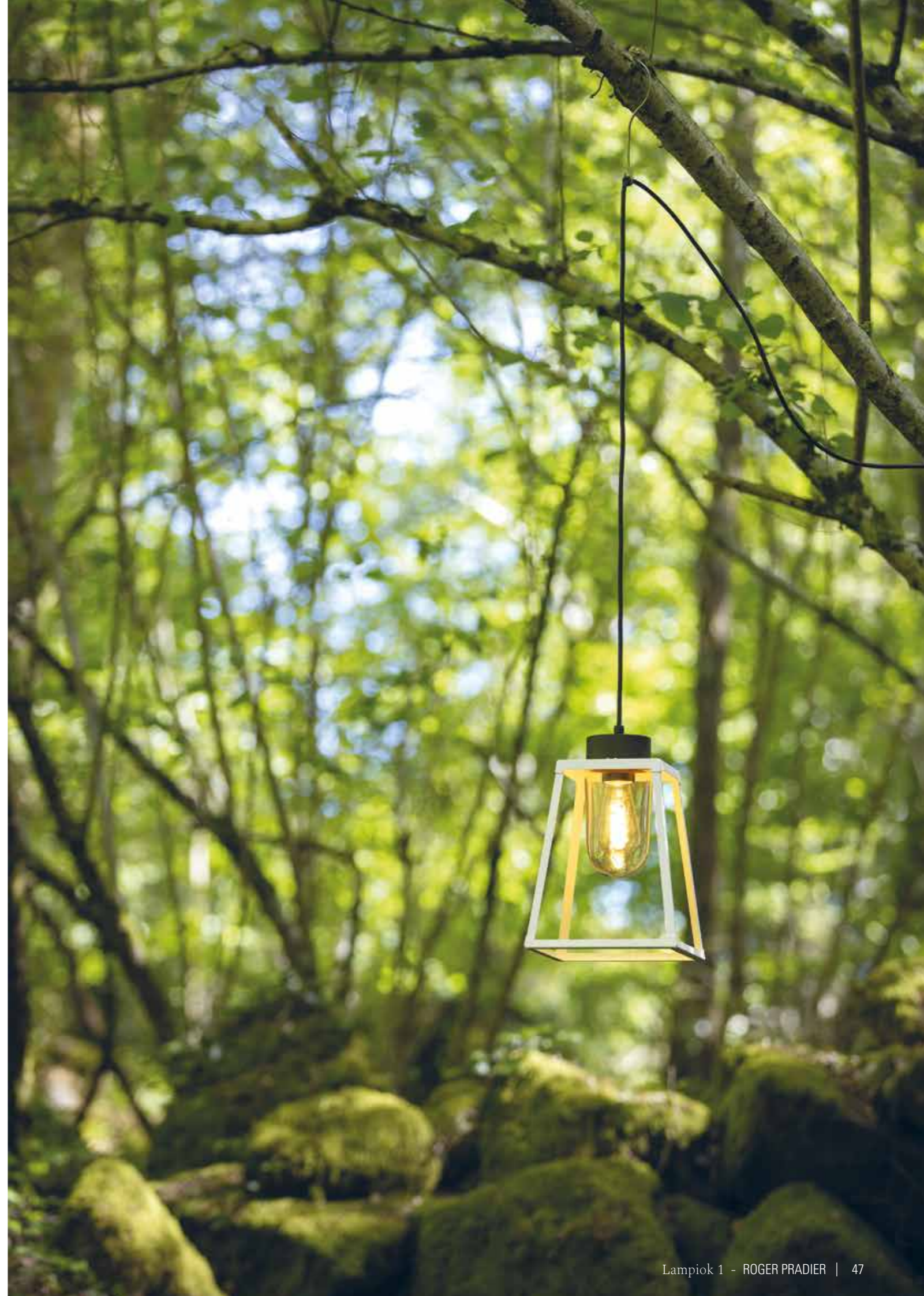

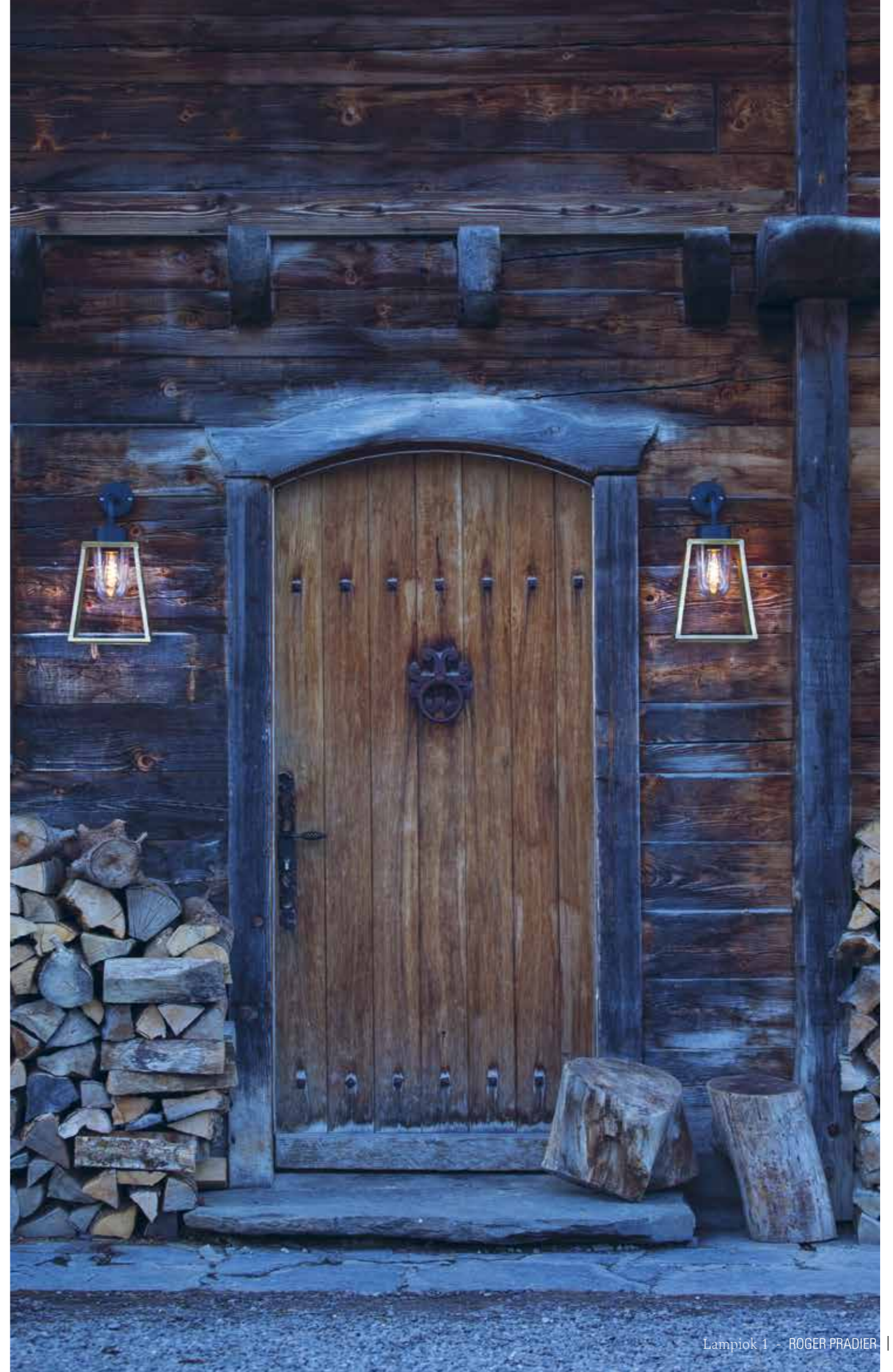

Lampio 1

Aluminium - Lacquered patinated copper - Tinted lacquered brass
 Clear or frosted glass diffuser
 Support (cup, rod, bracket and pole) Black grey 107 (RAL 7021)
 IP65 (lantern) / Class 2 / Class 1 (models 7 and 8)

SOURCE

E27 - 52W max Ø 68 mm - H 150 mm max

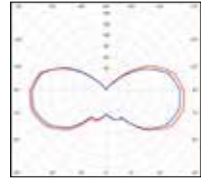

PRM Eav 20 lux p.304
 Model 7

E27 (2450lm)	Pathway	Spacing
H 2,50m	2,00m	3,00m

E27 (2450 lm)
 Real light output / frosted - 1558 lm
 Real light output / clear - 1673 lm

MODELS

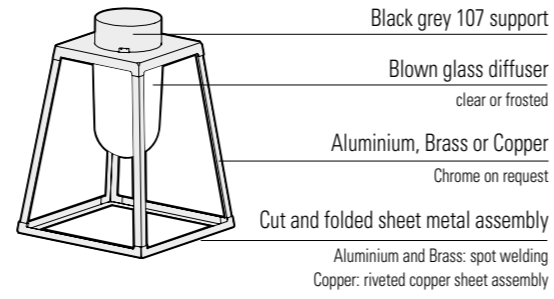
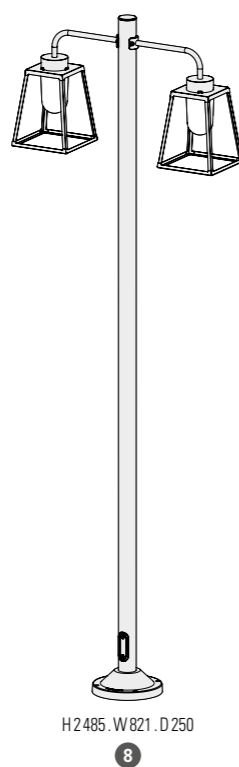
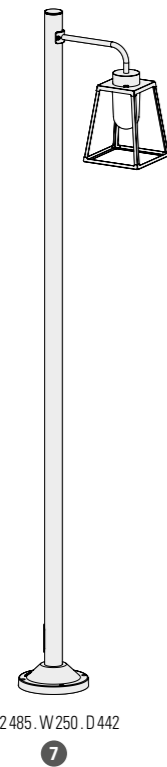
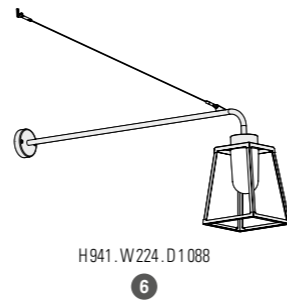

H 317 mm
 W 224 mm

Lampio 1

REFERENCES

Replace ●●● with the colour code or the material code / replace (●) with the country's electrical plug code

MODELS	DIFFUSERS	E27	CORNER PLATE
1	CLEAR GLASS	131 001 ●●●(●)	
	FROSTED GLASS	131 002 ●●●(●)	
2	CLEAR GLASS	131 003 ●●●	
	FROSTED GLASS	131 004 ●●●	
3	CLEAR GLASS	131 005 ●●●	
	FROSTED GLASS	131 006 ●●●	
4	CLEAR GLASS	131 007 ●●●	
	FROSTED GLASS	131 008 ●●●	
5	CLEAR GLASS	131 009 ●●●	147 005 ●●●
	FROSTED GLASS	131 010 ●●●	
6	CLEAR GLASS	131 011 ●●●	
	FROSTED GLASS	131 012 ●●●	
7	CLEAR GLASS	131 013 ●●●	
	FROSTED GLASS	131 014 ●●●	
8	CLEAR GLASS	131 015 ●●●	
	FROSTED GLASS	131 016 ●●●	

SPARE DIFFUSERS	
CLEAR GLASS	165 035 609
FROSTED GLASS	165 035 610

COLOURS CODES

Replace ●●● with the colour code

	RAL 7021 BLACK GREY 107		RAL 3013 TOMATO RED 110
	RAL 7044 SILK GREY 105		RAL 2004 PURE ORANGE 014
	WHITE 001		RAL 1016 SULFUR YELLOW 068
	RAL 9010 PURE WHITE 101		RAL 6025 FERN GREEN 109
	BLUE 111		

Other colours on request
 Support colour: Black grey 107 (RAL 7021) for all colours

MATERIAL CODES

Replace ●●● with the material code

	TINTED LACQUERED BRASS 070
	LACQUERED PATINATED COPPER 080

Support colour: Black grey 107 (RAL 7021) for all materials

PLUGS CODES

The standard Roger Pradier® plugs are SCHUKO plugs type F
 Except for French plugs, replace (●) with the country's plug code

	UK PLUG UK type G		SWISS PLUG CH type J
--	----------------------	--	-------------------------

MOUNTING

Wiring entry points in grey
 Fixing kit included

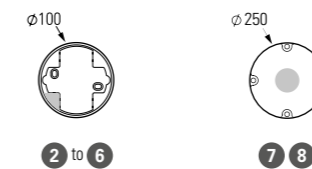

Lampiock 2

Design Stéphane Joyeux

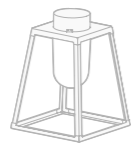

Lampiock 1

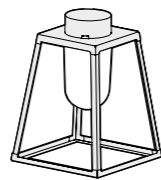

Lampiock 2

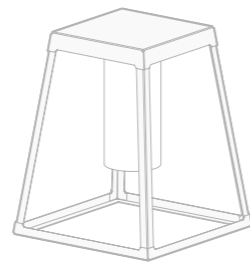

Lampiock 4





Lampio 2

Aluminium - Lacquered patinated copper - Tinted lacquered brass
 Clear or frosted glass diffuser
 Support (cup, rod, bracket and pole) Black grey 107 (RAL 7021)
 IP65 (lantern) / Class 1

SOURCE

E27 - 52W max Ø 80 mm - H 172 mm max

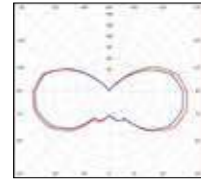

PRM Eav 20 lux p.304
 Model 3

E27 (2450 lm)	Pathway	Spacing
H 2,50 m	2,00m	3,00m

E27 (2450 lm)
 Real light output / frosted - 1558 lm
 Real light output / clear - 1673 lm

MODELS



H 780 . W 280

H 953 . W 280

H 547 . W 280 . D 460

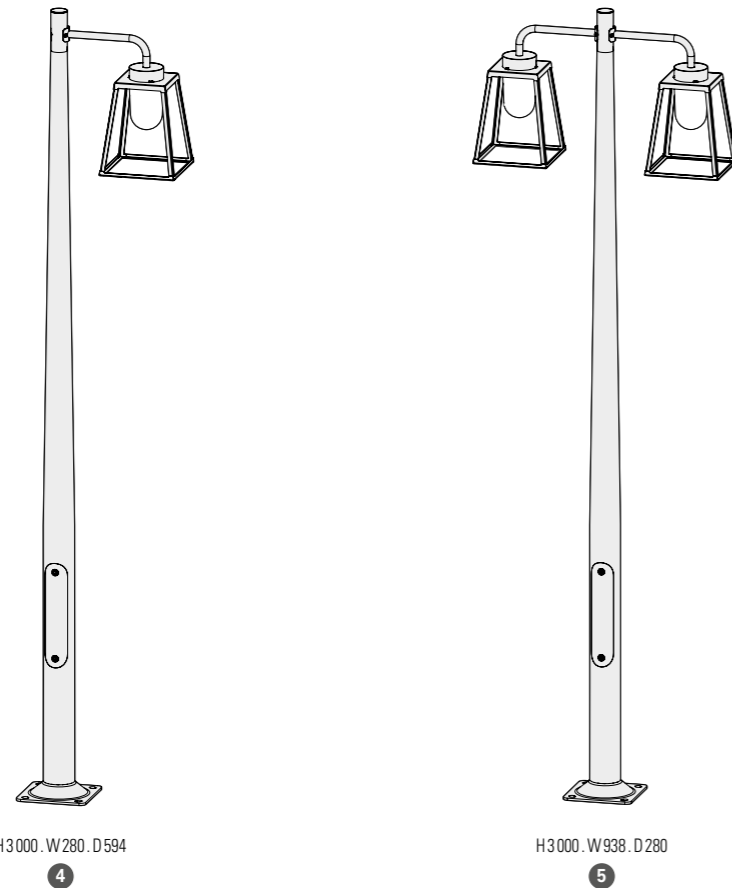

H 3 000 . W 280 . D 594

H 3 000 . W 938 . D 280

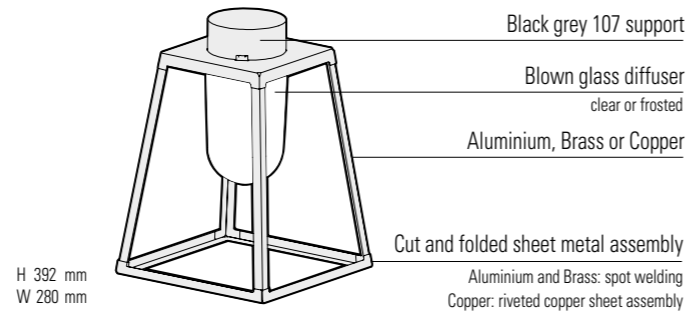

Black grey 107 support

Blown glass diffuser
 clear or frosted

Aluminium, Brass or Copper

Cut and folded sheet metal assembly

Aluminium and Brass: spot welding
 Copper: riveted copper sheet assembly

H 392 mm
 W 280 mm

REFERENCES

Replace ... with the colour code or the material code

MODELS	DIFFUSERS	E27	CORNER PLATE
1	CLEAR GLASS	178 001 ...	
	FROSTED GLASS	178 002 ...	
2	CLEAR GLASS	178 003 ...	
	FROSTED GLASS	178 004 ...	
3	CLEAR GLASS	178 005 ...	147 005 ...
	FROSTED GLASS	178 006 ...	
4	CLEAR GLASS	178 011 ...	
	FROSTED GLASS	178 012 ...	
5	CLEAR GLASS	178 013 ...	
	FROSTED GLASS	178 014 ...	
SPARE DIFFUSERS			
	CLEAR GLASS	165 095 609	
	FROSTED GLASS	165 095 610	

COLOURS CODES

Replace ... with the colour code

	RAL 7021 BLACK GREY 107		RAL 3005 WINE RED 066
	RAL 7044 SILK GREY 105		RAL 3013 TOMATO RED 110
	RAL 9010 PURE WHITE 101		RAL 2004 PURE ORANGE 014
	BLUE 111		RAL 1016 SULFUR YELLOW 068
			RAL 6025 FERN GREEN 109

Other colours on request
 Support colour: Black grey 107 (RAL 7021) for all colours

MATERIAL CODES

Replace ... with the material code

	TINTED LACQUERED BRASS 070
	LACQUERED PATINATED COPPER 080

Support colour: Black grey 107 (RAL 7021) for all materials

MOUNTING

Wiring entry points in grey
 Fixing kit included (except models 4 and 5)
 Anchor bolts on request (models 4 and 5) p.306

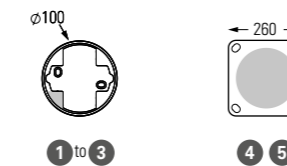

Lampiock 4

Design Stéphane Joyeux

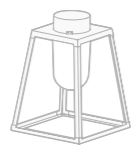

Lampiock 1

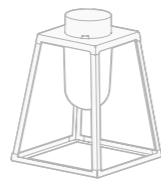

Lampiock 2

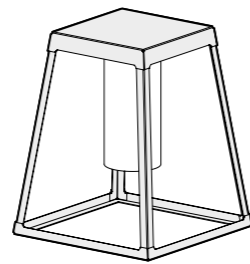

Lampiock 4





Lampio 4

Aluminium
 Opal or satin-finish PMMA diffuser (models 1, 3, 5)
 Satin-finish PMMA tube diffuser (models 2, 4, 6)
 Pole and bracket Black grey 107 (RAL 7021) for the two-colour version
 IP65 (lantern) / Class 1

SOURCES

LED 35W - 3000K warm white
 LED 35W - 4000K neutral white
 LED 70W - 3000K warm white (model 1)
 LED 70W - 4000K neutral white (model 1)

H 551 mm
 W 452 mm

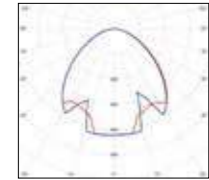
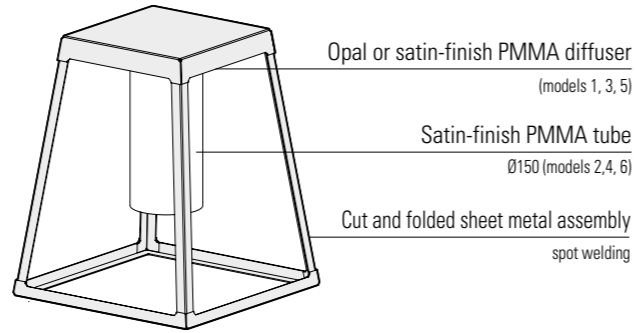

Models 1, 3 and 5

LED 35W
 Real light output / opal - 2720 lm
 Real light output / satin - 2940 lm
 CRI > 80

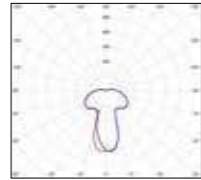

Models 2, 4 and 6

LED 35W
 Real light output - 3007 lm
 CRI > 80

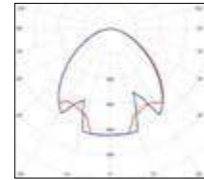

Model 1

LED 70W
 Real light output / opal - 5440 lm
 Real light output / satin - 5885 lm
 CRI > 80

PRM Eav 20 lux p.304
 Model 1

LED 70W	Pathway	Spacing
H 5,00m	5,00m	16,00m

PRM Eav 20 lux p.304
 Model 5

LED 2x35W	Pathway	Spacing
H 4,00m	5,00m	20,00m

MODELS

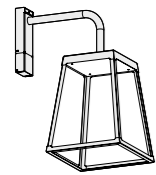

H 883 . W 452 . D 720

1

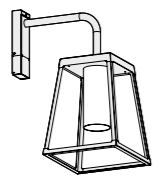

H 883 . W 452 . D 720

2

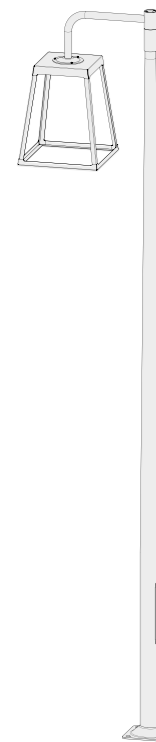

H 4 070 . W 452 . D 820

3



H 4 070 . W 452 . D 820

4

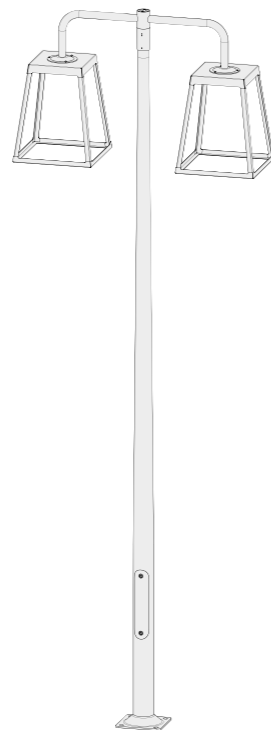

H 4 070 . W 452 . D 1390

5

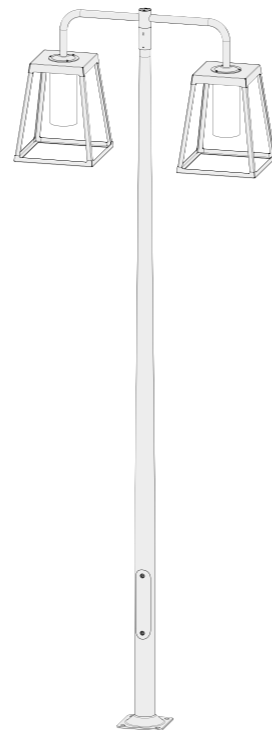

H 4 070 . W 452 . D 1390

6

Lampio 4

REFERENCES



Single-colour version



Two-colour version
 Black grey 107 support

Replace ●●● with the colour code

MODELS	DIFFUSERS	LED 35W 3000K warm white	LED 35W 4000K neutral white	LED 70W 3000K warm white	LED 70W 4000K neutral white
1	OPAL PMMA	175 001 ●●●	175 004 ●●●	175 007 ●●●	175 009 ●●●
	SATIN-FINISH PMMA	175 002 ●●●	175 005 ●●●	175 008 ●●●	175 010 ●●●
2	PMMA TUBE	175 003 ●●●	175 006 ●●●		
3	OPAL PMMA	175 011 ●●●	175 014 ●●●		
	SATIN-FINISH PMMA	175 012 ●●●	175 015 ●●●		
4	PMMA TUBE	175 013 ●●●	175 016 ●●●		
5	OPAL PMMA	175 017 ●●●	175 020 ●●●		
	SATIN-FINISH PMMA	175 018 ●●●	175 021 ●●●		
6	PMMA TUBE	175 019 ●●●	175 022 ●●●		

MODELS	DIFFUSERS	LED 35W 3000K warm white	LED 35W 4000K neutral white	LED 70W 3000K warm white	LED 70W 4000K neutral white
1	OPAL PMMA	175 201 ●●●	175 204 ●●●	175 207 ●●●	175 209 ●●●
	SATIN-FINISH PMMA	175 202 ●●●	175 205 ●●●	175 208 ●●●	175 210 ●●●
2	PMMA TUBE	175 203 ●●●	175 206 ●●●		
3	OPAL PMMA	175 211 ●●●	175 214 ●●●		
	SATIN-FINISH PMMA	175 212 ●●●	175 215 ●●●		
4	PMMA TUBE	175 213 ●●●	175 216 ●●●		
5	OPAL PMMA	175 217 ●●●	175 220 ●●●		
	SATIN-FINISH PMMA	175 218 ●●●	175 221 ●●●		
6	PMMA TUBE	175 219 ●●●	175 222 ●●●		

SPARE DIFFUSERS

OPAL PMMA	165 091 615
SATIN-FINISH PMMA	165 091 616
PMMA TUBE	165 092 612

COLOURS CODES

Replace ●●● with the colour code



Single-colour version

●	RAL 9005 JET BLACK	000
●	RAL 7021 BLACK GREY	107
●	RAL 7044 SILK GREY	105
●	RAL 9010 PURE WHITE	101
●	RAL 6009 FIR GREEN	067
●	RAL 3013 TOMATO RED	110
●	OLD RUSTIC	046

Other colours on request



Two-colour version
 Black grey 107 support

●	RAL 7044 SILK GREY	105
●	RAL 9010 PURE WHITE	101
●	RAL 6009 FIR GREEN	067
●	RAL 3013 TOMATO RED	110

Other colours on request

MOUNTING

Wiring entry points in grey
 Fixing kit included (except models 3 to 6)
 Anchor bolts on request (models 3 to 6) p.306

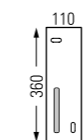

1 2

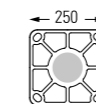

3 to 6

Tank

Design Cédric Ragot

Inspired by the New York water tanks, the Tank lamps are such as light storehouses.
Almost larger than life, contrasted finishes with opalescent diffuser and a wooden base, Tank lamps blend industrial codes and the habitat world to multiply usages.



Tank

Retified wood / Sandblasted stainless steel
Opal polypropylene diffuser
IP65 / Class 2

SOURCE

E27 - 60W max Ø80 mm - H 280 mm max

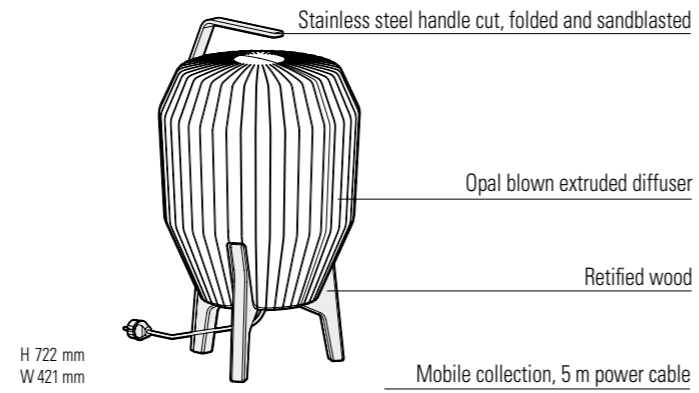

MODELS

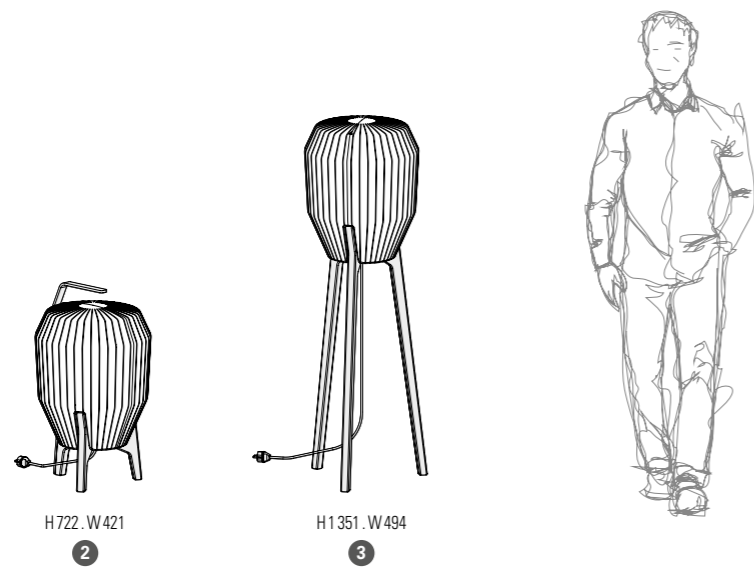

REFERENCES Replace (•) with the country's electrical plug code

MODELS	E27
2	159 002 998 (•)
3	159 003 998 (•)

PLUGS CODES The standard Roger Pradier® plugs are SCHUKO plugs type F
Except for French plugs, replace (•) with the country's plug code

UK PLUG UK
type G

SWISS PLUG CH
type J



Klint

Design Stéphane Joyeux



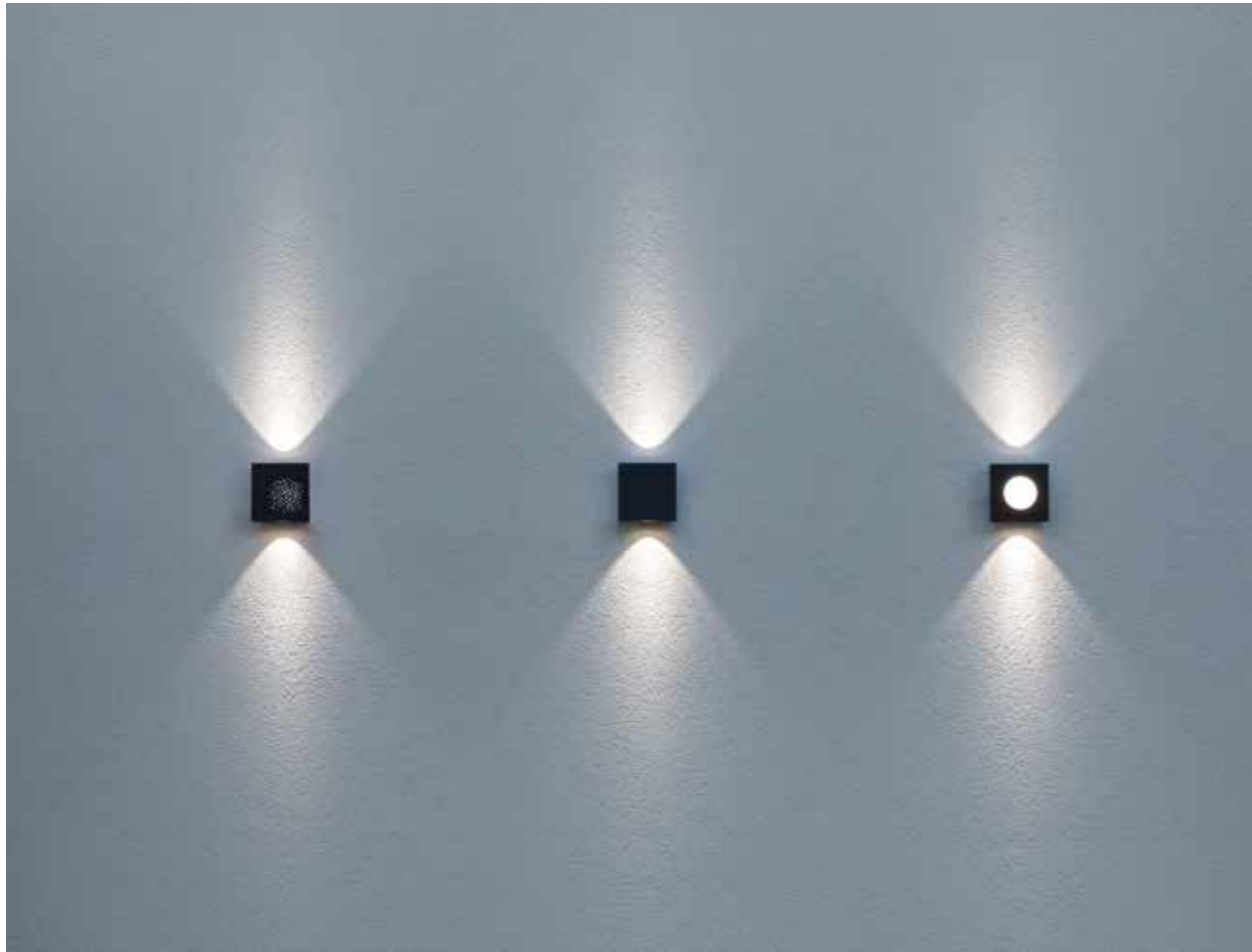

Klint

Aluminium - Lacquered brushed copper - Brushed stainless steel 316L
Clear PMMA diffuser
IP65 / Class 2

SOURCES

LED 2x2W - 2800K warm white
LED 2x2W - 4000K neutral white

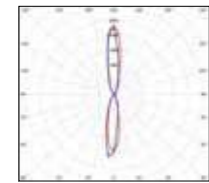

LED 2x2W - 40/40°
Real light output - 414 lm
CRI > 80

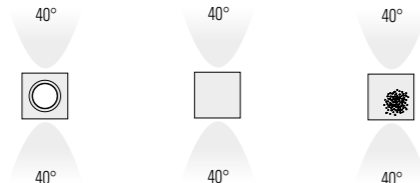

MODELS

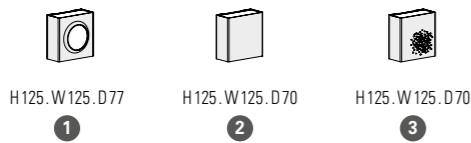

CUSTOMIZABLE SIGNAGE

on request

In red: printing on the diffuser



- 4 Square cut out 80x80mm + printing on diffuser
- 5 Laser cutting
- 6 Laser cutting + printing on diffuser

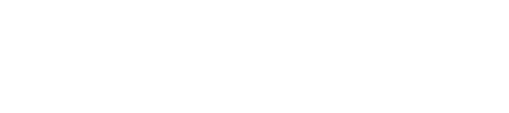
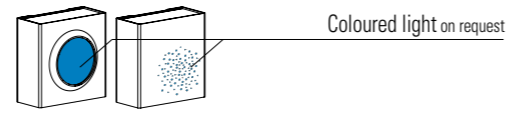
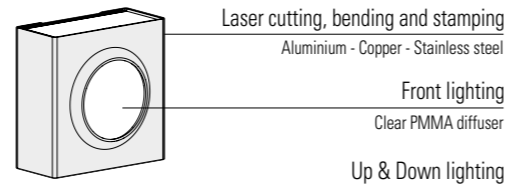

Klint

REFERENCES

Replace ... with the colour code or the material code

MODELS	LED 2x2W 2800K warm white	LED 2x2W 4000K neutral white
1	167 001 ...	167 002 ...
2	167 003 ...	167 004 ...
3	167 005 ...	167 006 ...

MODELS	LED 2x2W 2800K warm white	LED 2x2W 4000K neutral white
4	167 007 ...	167 008 ...
5	167 403 ...	167 404 ...
6	167 405 ...	167 406 ...

Customizable signage
on request

COLOURS CODES

Replace ... with the colour code

	VELVET BLACK 113		RAL 3005 WINE RED 066
	RAL 7021 BLACK GREY 107		RAL 3020 TRAFFIC RED 056
	RAL 7044 SILK GREY 105		RAL 2004 PURE ORANGE 014
	RAL 9010 PURE WHITE 101		RAL 1016 SULFUR YELLOW 068
	RAL 5011 STEEL BLUE 065		RAL 6009 FIR GREEN 067
	BLUE 111		RAL 6025 FERN GREEN 109

Other colours on request

MATERIAL CODES

Replace ... with the material code

	LACQUERED BRUSHED COPPER 084
	BRUSHED STAINLESS STEEL 018

MOUNTING

Wiring entry point in grey
Fixing kit included

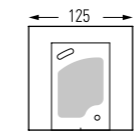

Cooper

Design Stéphane Joyeux





Cooper

Aluminium - Lacquered brushed copper or brass
 Galvanised steel - Black or white enamelled steel
 Clear or frosted blown glass diffuser
 Support (bracket and pole) Velvet black 113
 IP65 / Class 2

SOURCE

E27 - 52W max Ø68 mm - H150 mm max

MODELS

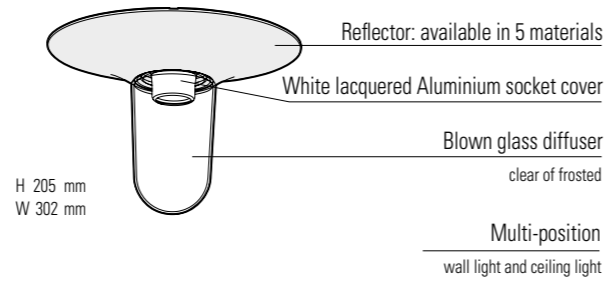

H302 . W205

1



H348 . W302 . D439

2

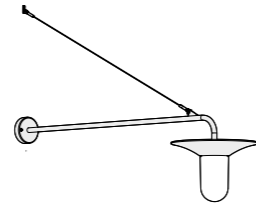

H782 . W302 . D1124

3

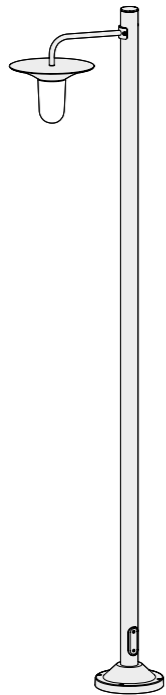

H2485 . W302 . D482

4

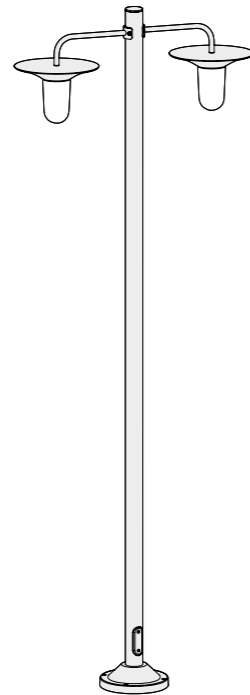

H2485 . W900 . D302

5



REFERENCES

Replace ... with the colour code or the material code

MODELS	DIFFUSERS	E27	CORNER PLATE
1	CLEAR GLASS	179 001 ...	
	FROSTED GLASS	179 002 ...	
2	CLEAR GLASS	179 003 ...	147 005 ...
	FROSTED GLASS	179 004 ...	
3	CLEAR GLASS	179 005 ...	
	FROSTED GLASS	179 006 ...	
4	CLEAR GLASS	179 007 ...	
	FROSTED GLASS	179 008 ...	
5	CLEAR GLASS	179 009 ...	
	FROSTED GLASS	179 010 ...	
SPARE DIFFUSERS			
	CLEAR GLASS	165 035 609	
	FROSTED GLASS	165 035 610	

COLOURS CODES

Replace ... with the colour code

	VELVET BLACK	113
	RAL 7021 BLACK GREY	107
	RAL 7044 SILK GREY	105
	RAL 9016 TRAFFIC WHITE	114
	RAL 5009 MATTE AZURE BLUE	134
	BLUE	111
	RAL 3005 WINE RED	066
	RAL 3013 TOMATO RED	110
	RAL 2004 PURE ORANGE	014
	RAL 1016 GLOSSY SULFUR YELLOW	057
	RAL 6025 FERN GREEN	109
	OLD RUSTIC	046

Other colours on request
 Support colour: Velvet black 113 for all colours

MATERIAL CODES

Replace ... with the material code

	LACQUERED BRUSHED COPPER	084
	LACQUERED BRUSHED BRASS	075
	GALVANISED STEEL	130
	WHITE ENAMELLED STEEL	131
	BLACK ENAMELLED STEEL	132

Support colour: Velvet black 113 for all materials

MOUNTING

Wiring entry points in grey
 Fixing kit included

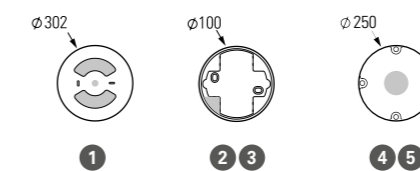

Cooper

Séléné

Design Normal Studio

Séléné has a presence that is almost sculptural. This range, which comes with pureness of line, was born of close observation of the know-how gained from the techniques of tin-smithing.

"The generosity of the form calls to mind the leaf of the water lily. The velvety appearance of the colours chosen is a counterpart to the downy surfaces of some plants," say Jean-François Dingjian and Eloi Chafai.

The masked light source gives out a beautiful luminous halo that plays with the colour of the support.

Label VIA 2011



Séléné

Aluminium
Opal polycarbonate diffuser
IP65 / Class 2

SOURCES

LED 13W - 2900K warm white - triac dimmable
LED 21W - 4000K neutral white

MODELS

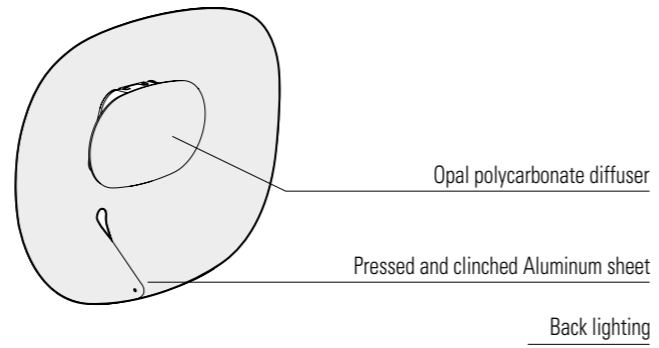
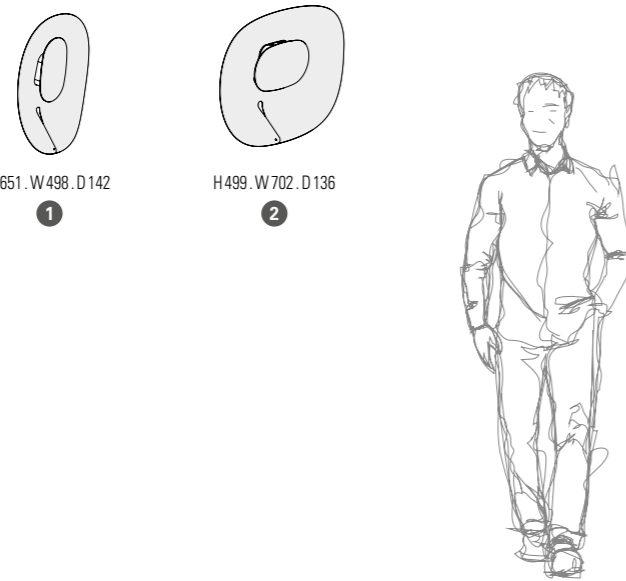

REFERENCES

Replace ●●● with the colour code

MODELS	LED 13W 2900K warm white	LED 21W 4000K neutral white
1	155 001 ●●●	155 002 ●●●
2	155 003 ●●●	155 004 ●●●

COLOURS CODES

Replace ●●● with the colour code

	RAL 7044 SILK GREY 105		RAL 2004 PURE ORANGE 014
	RAL 9010 PURE WHITE 101		RAL 1016 SULFUR YELLOW 068
	BLUE 111	Other colours on request	

MOUNTING

Wiring entry points in grey
Fixing kit included

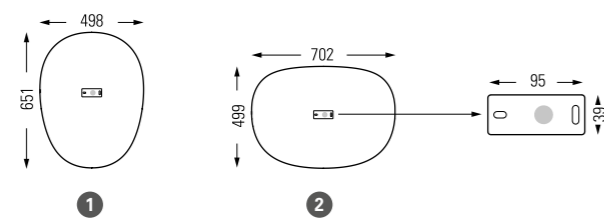

RP195

Design Stéphane Joyeux



RP195

Aluminium - Raw copper - Brushed stainless steel
 Clear or frosted glass diffuser
 IP65 / Class 1 (models 3 and 4) / Class 2 (models 1 and 2)

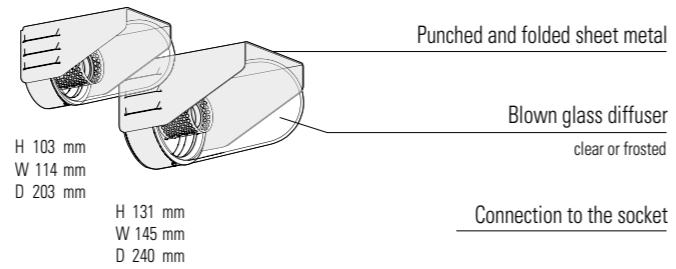

SOURCES

E27 - 52W max (models 1 and 3) Ø68 mm - H150 mm max
 E27 - 70W max (models 2 and 4) Ø68 mm - H150 mm max

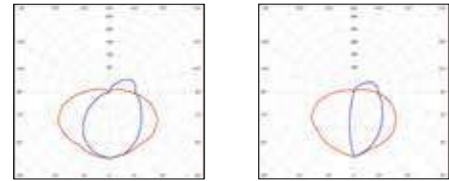

Models 1 and 3

Models 2 and 4

PRM Eav 20 lux p.304
 Models 1 and 3

E27 (2450 lm)	Pathway	Spacing
H 2,00 m	2,00 m	2,50 m

E27 (2450 lm) E27 (2450 lm)
 Real light output /frosted - 1106 lm Real light output /frosted - 1024 lm
 Real light output /clear - 1085 lm Real light output /clear - 977 lm

MODELS

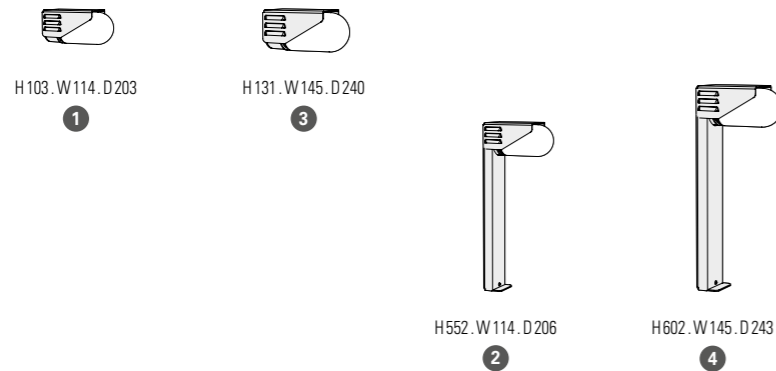

REFERENCES

Replace ... with the colour code or the material code

MODELS	DIFFUSERS	E27
1	CLEAR GLASS	153 001 ...
	FROSTED GLASS	153 002 ...
2	CLEAR GLASS	153 003 ...
	FROSTED GLASS	153 004 ...
3	CLEAR GLASS	153 005 ...
	FROSTED GLASS	153 006 ...
4	CLEAR GLASS	153 007 ...
	FROSTED GLASS	153 008 ...
SPARE DIFFUSERS		
	CLEAR GLASS (models 1 and 2)	165 035 609
	FROSTED GLASS (models 1 and 2)	165 035 610
	CLEAR GLASS (models 3 and 4)	165 095 609
	FROSTED GLASS (models 3 and 4)	165 095 610

MOUNTING

Wiring entry points in grey
 Fixing kit included

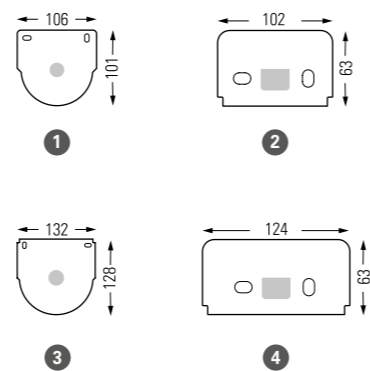

COLOURS CODES

Replace ... with the colour code

	VELVET BLACK 113		RAL 3020 TRAFFIC RED 056
	DARK GREY 006		RAL 2004 PURE ORANGE 014
	SLATE GREY 059		RAL 1016 SULFUR YELLOW 068
	RAL 7044 SILK GREY 105		RAL 6025 FERN GREEN 109
	OLD RUSTIC 046		RAL 6021 PALE GREEN 133
	RAL 3005 WINE RED 066		Other colours on request

MATERIAL CODES

Replace ... with the material code

	RAW COPPER 082
	STAINLESS STEEL 018
	Bollard colour: Jet black 000 (RAL 9005) for raw copper



Factory

Design Stéphane Joyeux



Faktory

Aluminium - Lacquered copper - Raw zinc
Clear glass diffuser
IP44 / Class 1

SOURCE

E27 - 70W max Ø68 mm - H 160 mm max

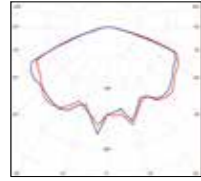

E27 (2450 lm)
Real light output - 1530 lm

PRM Eav 20 lux p.304
Model 5

E27 (2450 lm)	Pathway	Spacing
H 2,50 m	2,50 m	8,00 m

MODELS



H223 .W346 .D438

H500 .W346

H2000 .W346

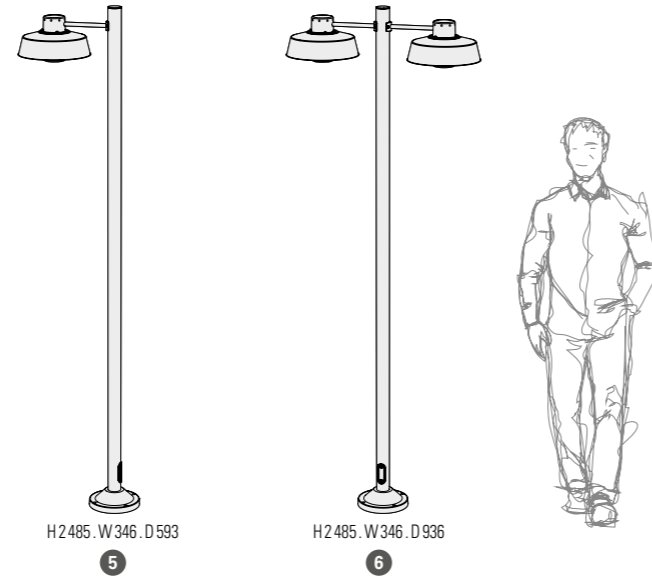

H2485 .W346 .D593

H2485 .W346 .D936

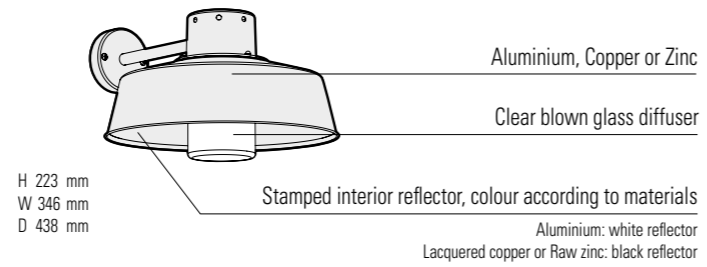

REFERENCES

Replace ... with the colour code or the material code

MODELS	E27	CORNER PLATE
1	122 001 ...	147 005 ...
2	122 002 ...	
3	122 003 ...	
5	122 004 ...	
6	122 005 ...	
SPARE DIFFUSER		
	165 001 609	

COLOURS CODES

Replace ... with the colour code

	RAL 7021 BLACK GREY 107		RAL 7044 SILK GREY 105		RAL 3013 TOMATO RED 110
	SLATE GREY 059		RAL 9010 PURE WHITE 101		OLD RUSTIC 046

Other colours on request

MATERIAL CODES

Replace ... with the material code

	LACQUERED BRUSHED COPPER 084		RAW ZINC 092
--	------------------------------	--	--------------

Support colour: Jet black 000 (RAL 9005) for all materials

MOUNTING

Wiring entry points in grey
Fixing kit included

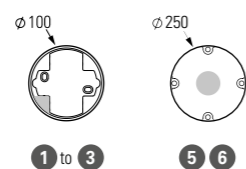

Hugy

Design Stéphane Joyeux

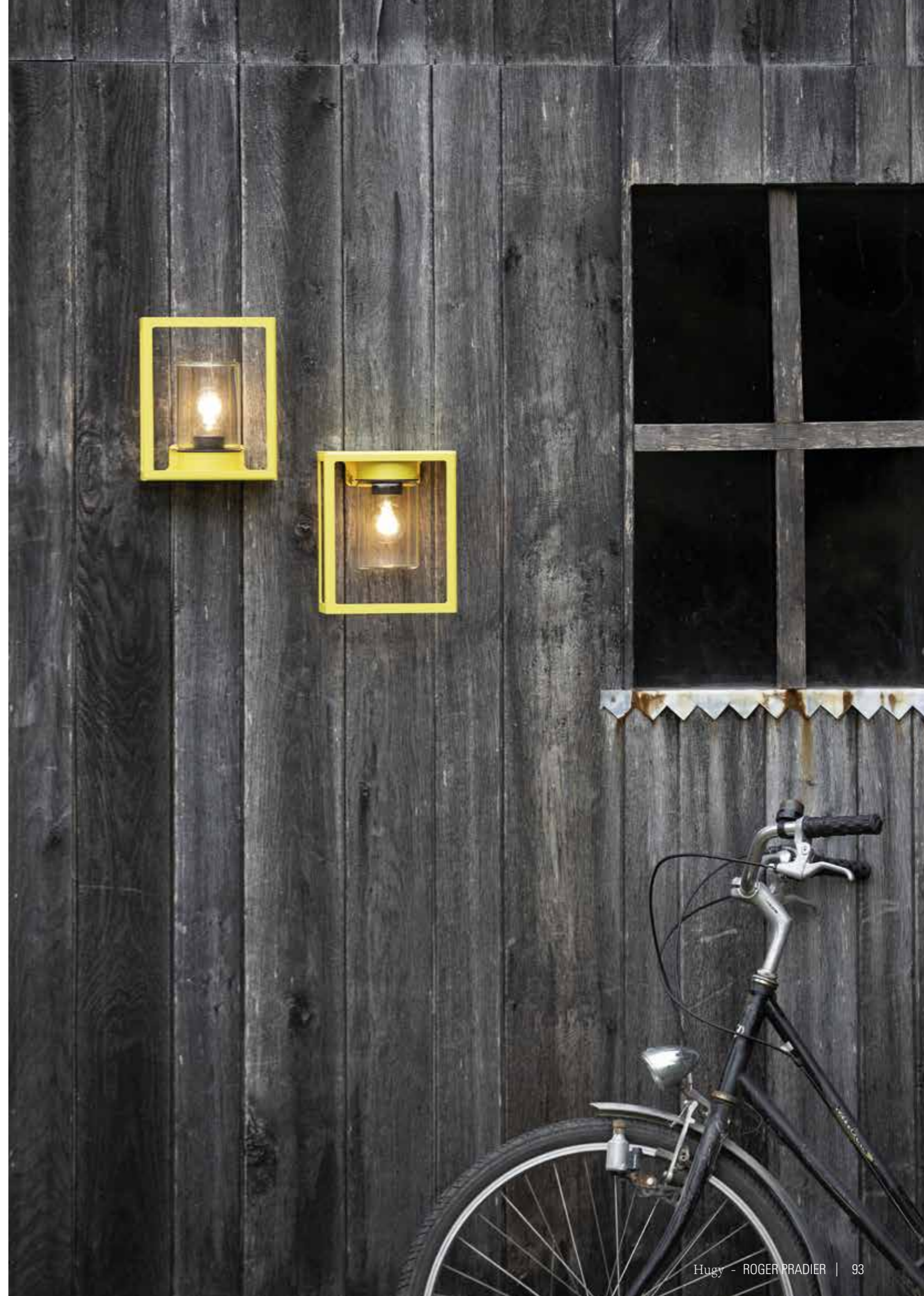

Hugy

Aluminium
Clear glass or frosted diffuser
IP65 / Class 2

SOURCE

E27 - 42W max Ø68 mm - H130 mm max

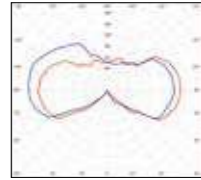

E27 (2450 lm)
Real light output / frosted - 2286 lm
Real light output / clear - 1939 lm

MODEL

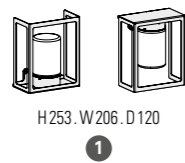

H 253. W 206. D 120

1

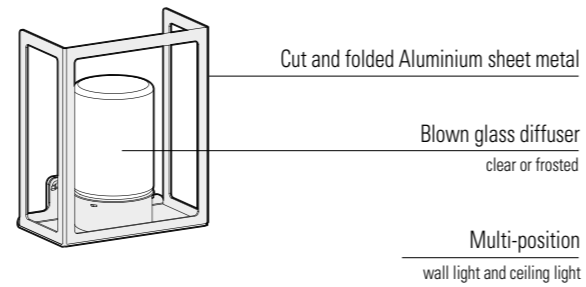











REFERENCES

Replace ●●● with the colour code

MODEL	DIFFUSERS	E27
1	CLEAR GLASS	125 001 ●●●
	FROSTED GLASS	125 002 ●●●
SPARE DIFFUSERS		
	CLEAR GLASS	165 001 609
	FROSTED GLASS	165 001 610

COLOURS CODES

Replace ●●● with the colour code

	RAL 7021 BLACK GREY 107		OLD RUSTIC 046
	DARK GREY 006		RAL 3020 TRAFFIC RED 056
	SLATE GREY 059		RAL 2004 PURE ORANGE 014
	RAL 7044 SILK GREY 105		RAL 6025 FERN GREEN 109
	RAL 9010 PURE WHITE 101		RAL 1016 SULFUR YELLOW 068

Other colours on request

MOUNTING

Wiring entry point in grey
Fixing kit included

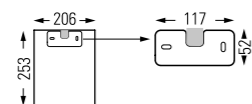

1



Grumo

Design Stéphane Joyeux



Grumo

Aluminium
Opal polycarbonate diffuser
IP65 / IK09 / Class 1

SOURCE

E27 - 52W max Ø 120 mm - H 280 mm max

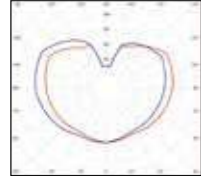

E27 (2450 lm)
Real light output - 1572 lm

MODELS

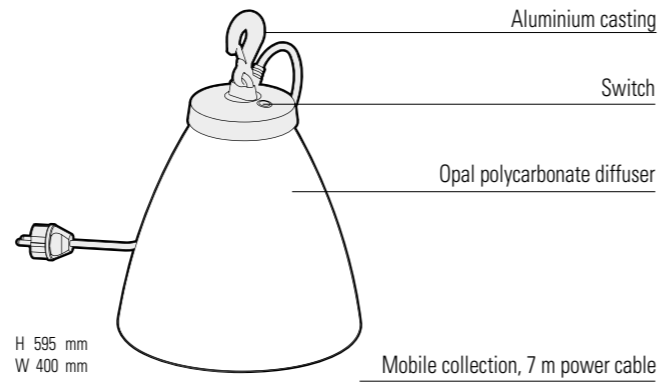
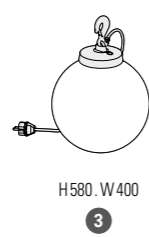







REFERENCES

Replace **•••** with the colour code / replace **(•)** with the country's electrical plug code

MODELS	E27	SPARE DIFFUSERS
1	124 001 •••(•)	165 027 602
3	124 002 •••(•)	165 028 602

COLOURS CODES

Replace **•••** with the colour code ↴

	RAL 7021 BLACK GREY 107		RAL 3020 TRAFFIC RED 056
	RAL 7044 SILK GREY 105		RAL 2004 PURE ORANGE 014
	RAL 5011 STEEL BLUE 065		RAL 6018 YELLOW GREEN 015
Other colours on request			RAL 6021 PALE GREEN 133

PLUGS CODES

The standard Roger Pradier® plugs are SCHUKO plugs type F
Except for French plugs, replace **(•)** with the country's plug code ↴

	UK PLUG UK type G		SWISS PLUG CH type J
---	-----------------------------	---	--------------------------------



Kent

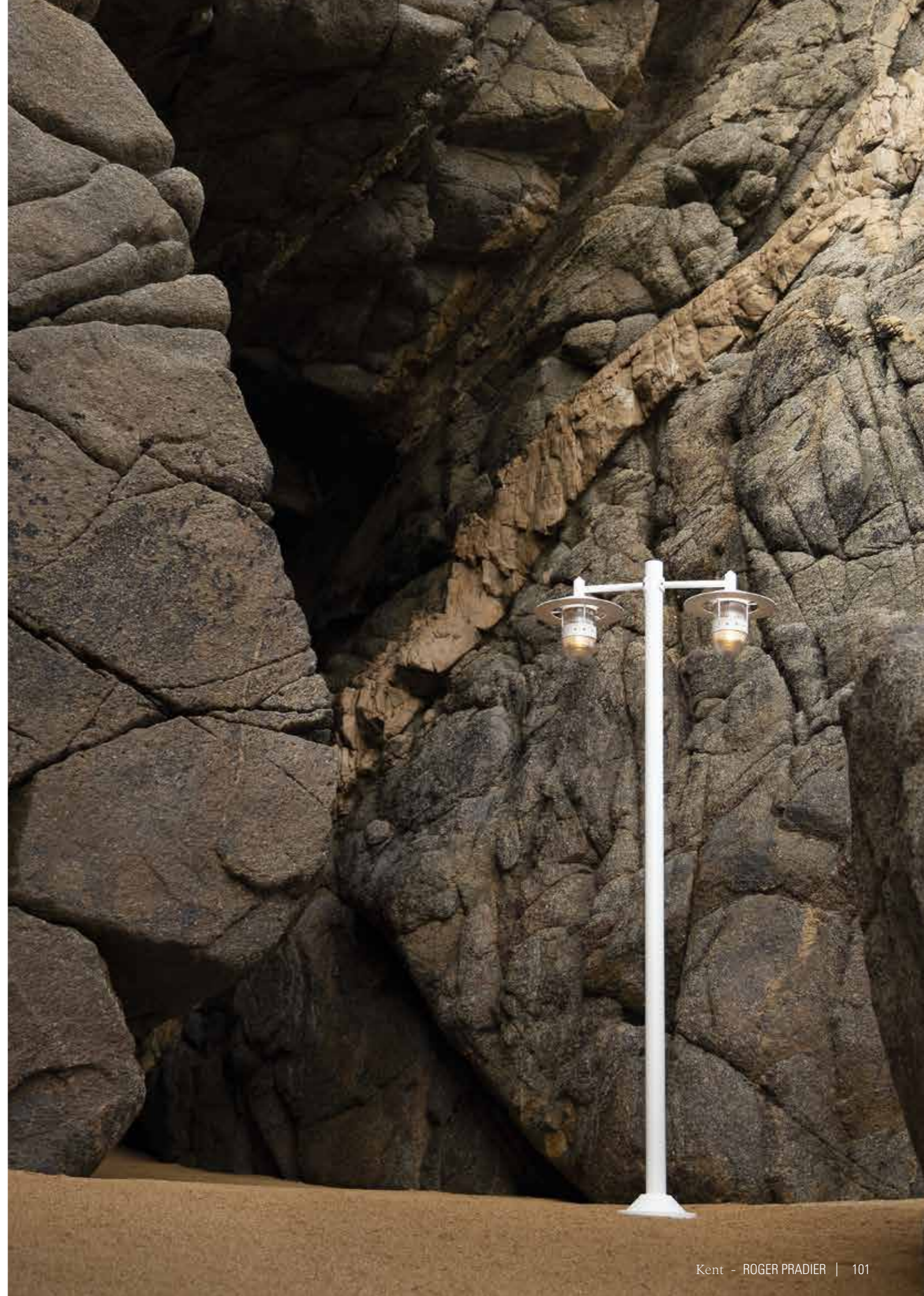

Kent

Aluminium
Prismatic clear glass diffuser
IP44 / Class 1

SOURCE

E27 - 105W max Ø80 mm - H140 mm max

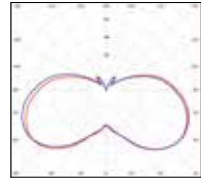

PRM Eav 20 lux p.304
Model 4

E27 (2450 lm)	Pathway	Spacing
H 2,20m	2,50m	3,50m

E27 (2450 lm)
Real light output - 2055 lm

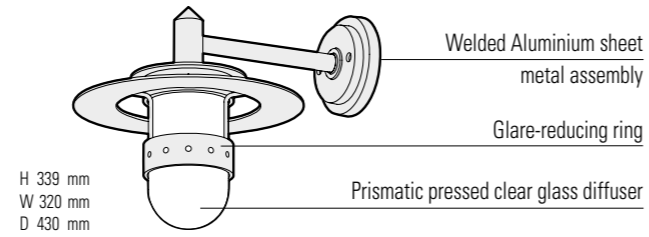

MODELS



H 330 . W 320

1

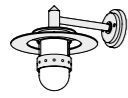

H 339 . W 320 . D 430

2

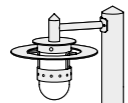

H 1 001 . W 320 . D 517

3

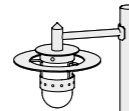

H 2 185 . W 320 . D 559

4

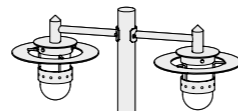

H 2 185 . W 320 . D 869

5



REFERENCES

Replace ●●● with the colour code

MODELS	E27
1	127 001 ●●●
2	127 002 ●●●
3	127 003 ●●●
4	127 004 ●●●
5	127 005 ●●●
SPARE DIFFUSER	
	165 030 609

COLOURS CODES

Replace ●●● with the colour code

■	RAL 7021 BLACK GREY	107	■	RAL 3013 TOMATO RED	110
■	DARK GREY	006	■	RAL 5011 STEEL BLUE	065
■	SLATE GREY	059	■	BLUE	111
■	RAL 7044 SILK GREY	105	■	OLD RUSTIC	046
■	RAL 9010 PURE WHITE	101		Other colours on request	

MOUNTING

Wiring entry points in grey
Fixing kit included

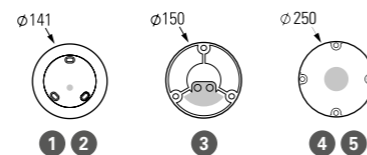

Sherlock

Design Stéphane Joyeux



Sherlock

Aluminium
Clear glass or frosted diffuser
IP65 / Class 1 (models 3 and 4) / Class 2 (models 1 and 2)

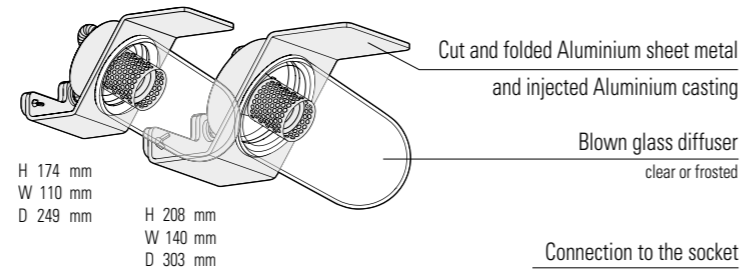

SOURCES

E27 - 42W max Ø 68 mm - H 150 mm max

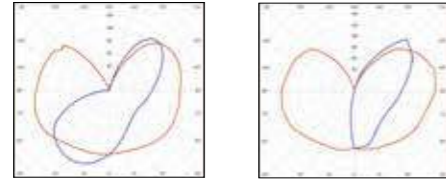

Models 1 and 3
E27 (2450 lm)
Real light output / frosted - 1757 lm
Real light output / clear - 1857 lm

Models 2 and 4
E27 (2450 lm)
Real light output / frosted - 1624 lm
Real light output / clear - 1698 lm

PRM Eav 20 lux p.304
Models 1 and 3

E27 (2450 lm)	Pathway	Spacing
H 2,00m	2,00m	6,00m

MODELS

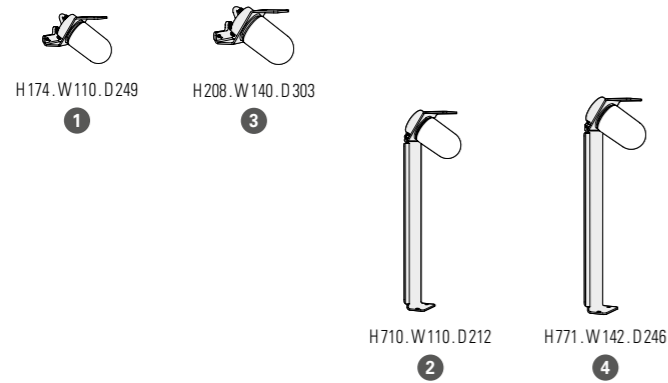

REFERENCES

Replace ●●● with the colour code

MODELS	DIFFUSERS	E27
1	CLEAR GLASS	154 001 ●●●
	FROSTED GLASS	154 002 ●●●
2	CLEAR GLASS	154 003 ●●●
	FROSTED GLASS	154 004 ●●●
3	CLEAR GLASS	154 005 ●●●
	FROSTED GLASS	154 006 ●●●
4	CLEAR GLASS	154 007 ●●●
	FROSTED GLASS	154 008 ●●●

SPARE DIFFUSERS	
CLEAR GLASS (models 1 and 2)	165 035 609
FROSTED GLASS (models 1 and 2)	165 035 610
CLEAR GLASS (models 3 and 4)	165 095 609
FROSTED GLASS (models 3 and 4)	165 095 610

MOUNTING

Wiring entry points in grey
Fixing kit included

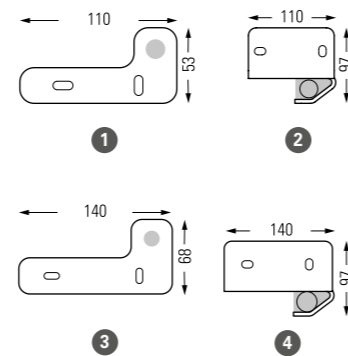

COLOURS CODES

Replace ●●● with the colour code

	VELVET BLACK 113		OLD RUSTIC 046
	RAL 7021 BLACK GREY 107		RAL 3020 TRAFFIC RED 056
	DARK GREY 006		RAL 2004 PURE ORANGE 014
	SLATE GREY 059		RAL 1016 SULFUR YELLOW 068
	RAL 7044 SILK GREY 105		RAL 6025 FERN GREEN 109
	RAL 9010 PURE WHITE 101		

Other colours on request



Mona

Design Stéphane Joyeux



Mona

Aluminium
Opal polycarbonate diffuser
IP65 / IK10 / Class 2

SOURCES

LED 35W - 2700K warm white - triac dimmable
LED 35W - 4500K neutral white - triac dimmable
2Gx13 FLC 22W

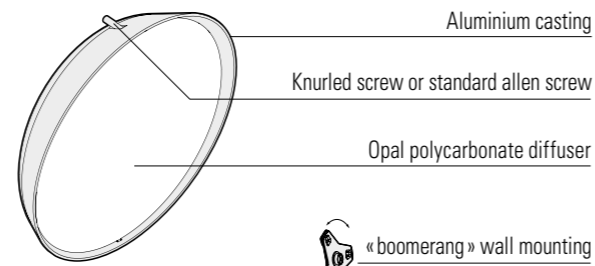

H 347 mm
W 347 mm
D 108 mm

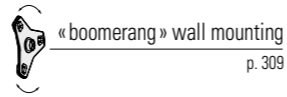

Multi-position
wall or ceiling mounted

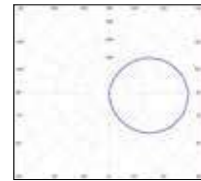

PRM Eav 20 lux p.304
Model 1

LED 35W	Pathway	Spacing
H 2,00m	2,00m	4,00m

LED 35W
Real light output - 1349 lm
CRI > 80

MODEL

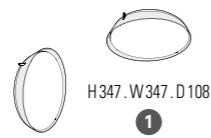

REFERENCES

Replace ●●● with the colour code

MODEL	2Gx13 FLC 22W	LED 35W 2700K warm white	LED 35W 4500K neutral white	SPARE DIFFUSER
1	137 001 ●●●	137 002 ●●●	137 003 ●●●	165 043 602

COLOURS CODES

Replace ●●● with the colour code

	RAL 9005 JET BLACK 000
	VELVET BLACK 113
	RAL 7021 BLACK GREY 107
	RAL 7044 SILK GREY 105
	White 001

Other colours on request

	SANDSTONE 054
	RAL 3013 TOMATO RED 110
	RAL 2004 PURE ORANGE 014
	RAL 1016 SULFUR YELLOW 068
	RAL 5011 STEEL BLUE 065
	BLUE 111

MOUNTING

Wiring entry point in grey
Fixing kit included

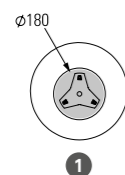

Equix

Design Stéphane Joyeux



Equix

Aluminium and Bichromated steel (base)
Toughened borosilicate glass diffuser
IP55 / Class 1

SOURCE

LED 35W - 4000K neutral white
Initial flux - 5500 lm
CRI > 80

MODELS

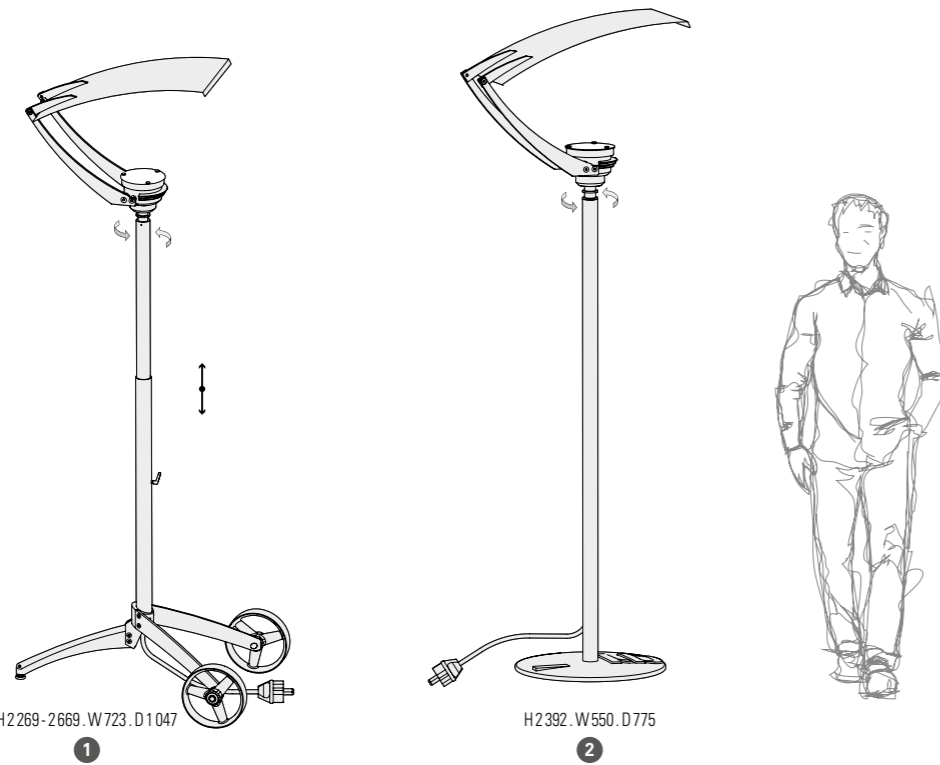
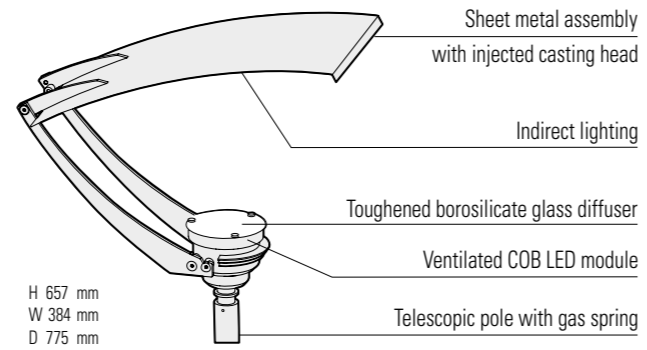

REFERENCES

Replace ●●● with the colour code / replace (●) with the country's electrical plug code

MODELS	LED 35W 4000K neutral white
1	121 001 ●●●(●)
2	121 002 ●●●(●)
SPARE DIFFUSER	
165 026 610	

COLOURS CODES

Replace ●●● with the colour code ↴

	RAL 7021 BLACK GREY	107
	RAL 7044 SILK GREY	105
	RAL 3005 WINE RED	066
	RAL 5011 STEEL BLUE	065

Other colours on request

PLUGS CODES

The standard Roger Pradier® plugs are SCHUKO plugs type F
Except for French plugs, replace (●) with the country's plug code ↴

	UK PLUG UK type G		SWISS PLUG CH type J
--	----------------------	--	-------------------------



Square

Design Patrick Norguet

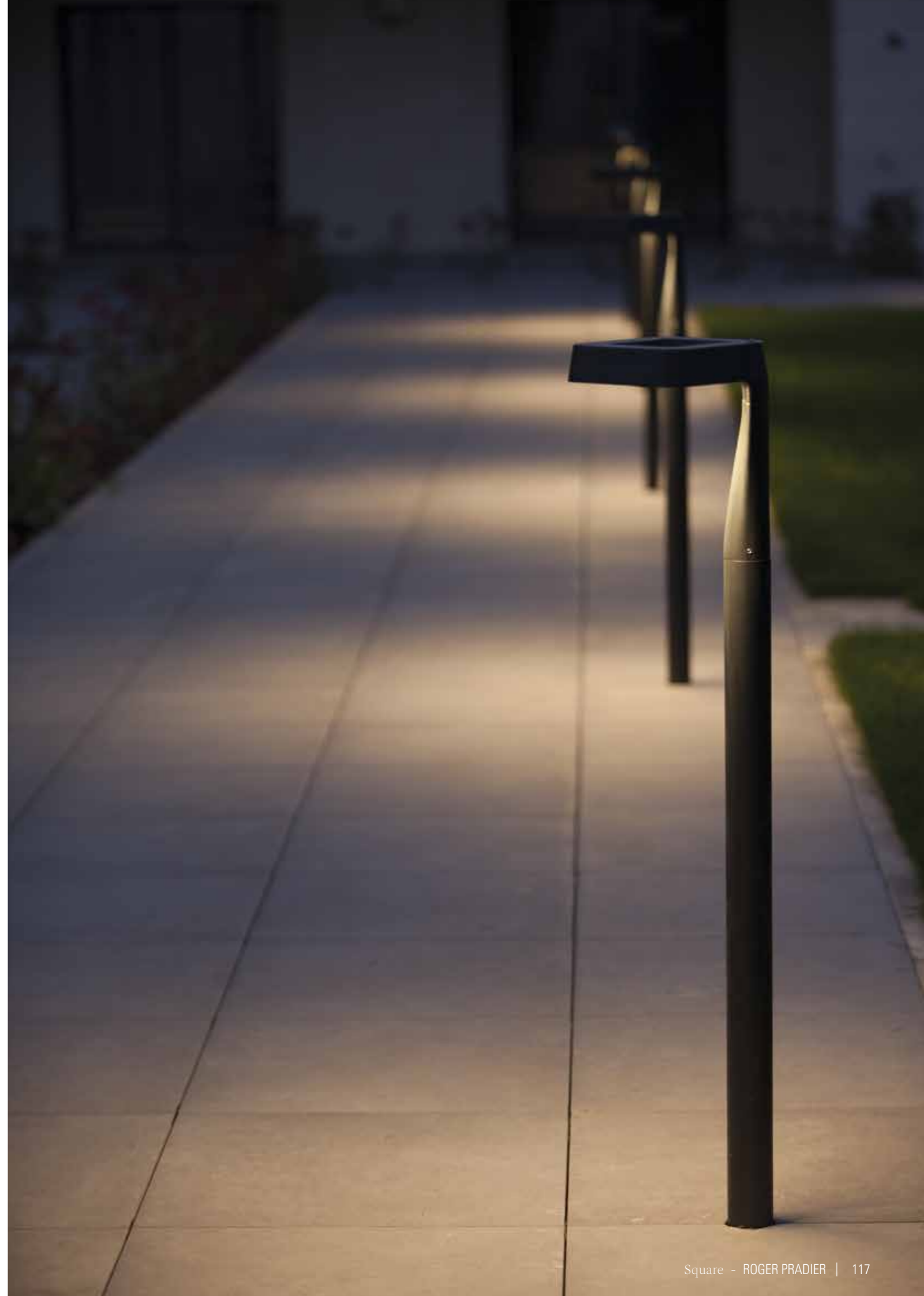

Square

Aluminium
Satin-finish polycarbonate diffuser
IP65 / IK09 / Class 1

SOURCES

LED 30W - 2700K warm white
LED 30W - 4000K neutral white

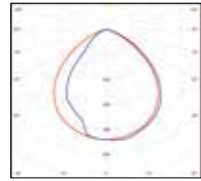

Model 1

LED 30W
Real light output - 2716 lm
CRI > 80



Models 2 to 4

LED 30W
Real light output - 2691 lm
CRI > 80

MODELS



1

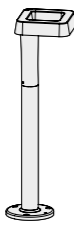

H796 . W268

2

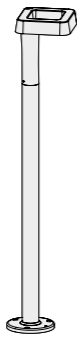

H1246 . W268

3

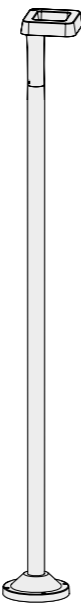

H2292 . W303

4



REFERENCES

Replace **•••** with the colour code

MODELS	LED 30W 2700K warm white	LED 30W 4000K neutral white
1	156 002 •••	156 001 •••
2	156 004 •••	156 003 •••
3	156 006 •••	156 005 •••
4	156 008 •••	156 007 •••

COLOURS CODES

Replace **•••** with the colour code

	RAL 7021 BLACK GREY 107		WHITE 001
	DARK GREY 006		RAL 3013 TOMATO RED 110
	RAL 7044 SILK GREY 105		LIMESTONE 053

Other colours on request

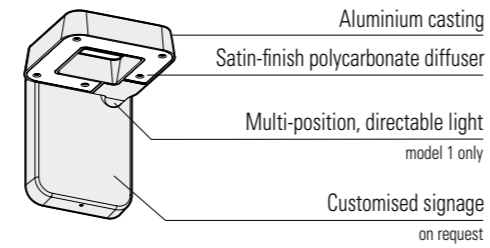

OL11

—

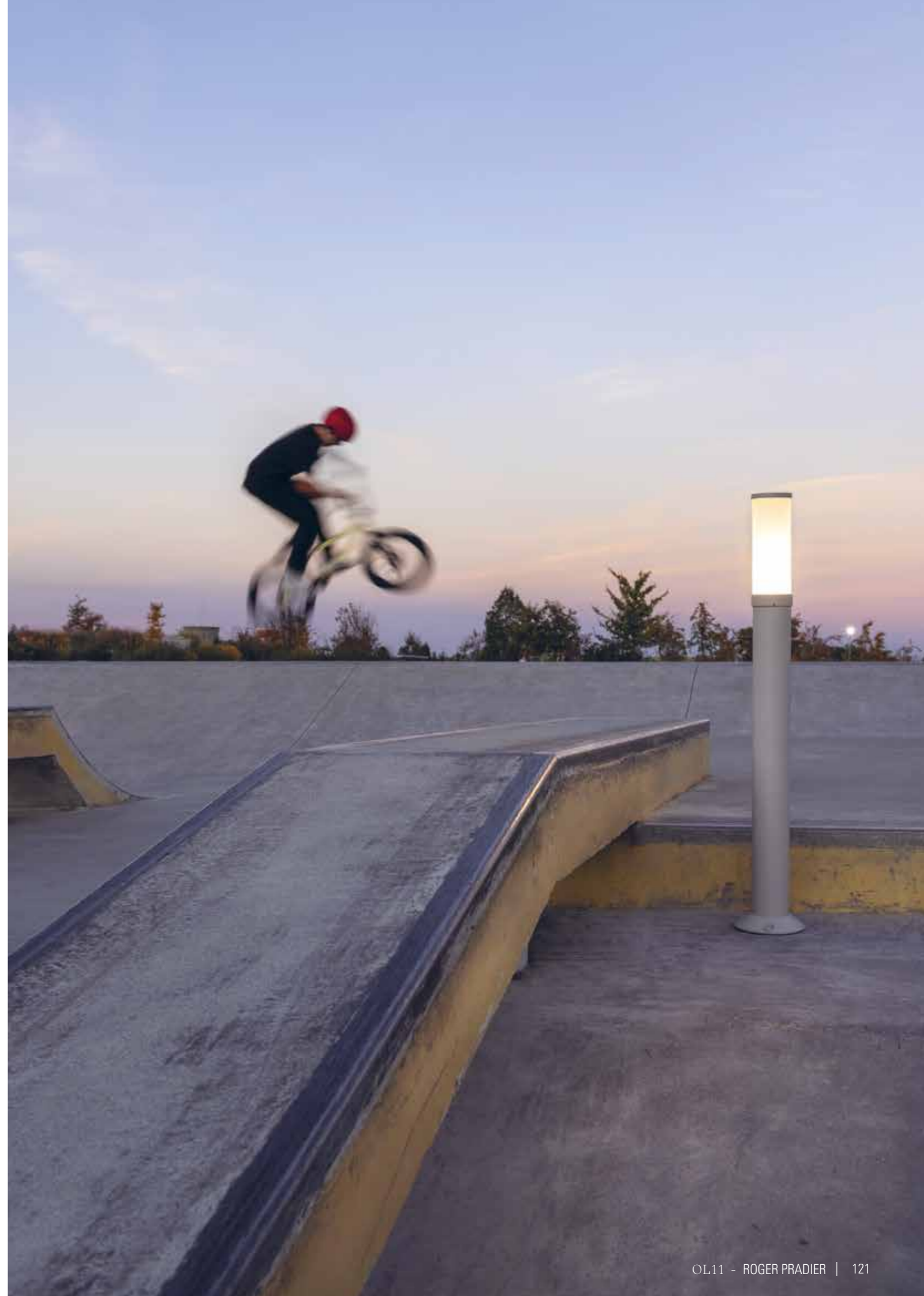

OL11

Aluminium
Satin-finish PMMA diffuser
IP55 / Class 1

SOURCE

E27 - 30W max Ø 64 mm - H 200 mm max

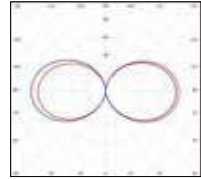

PRM Eav 20 lux p.304
Model 4

E27 (2450 lm)	Pathway	Spacing
H 0,95 m	2,00 m	6,00 m

E27 (2450 lm)
Real light output - 1719 lm

MODELS

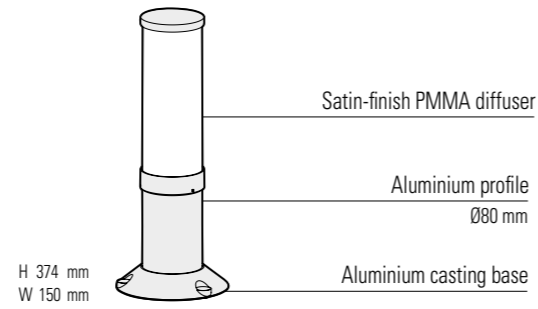
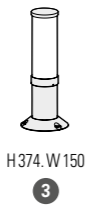
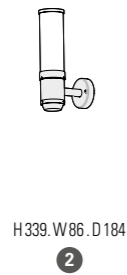
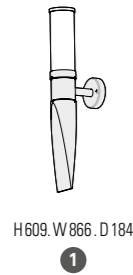

REFERENCES

Replace ●●● with the colour code

MODELS	E27
1	142 201 ●●●
2	142 202 ●●●
3	142 203 ●●●
4	142 204 ●●●

COLOURS CODES

Replace ●●● with the colour code

■	RAL 7021 BLACK GREY	107
■	RAL 7044 SILK GREY	105
■	RAL 3013 TOMATO RED	110
■	OLD RUSTIC	046

Other colours on request

MOUNTING

Wiring entry points in grey
Fixing kit included

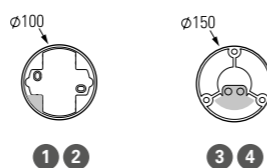

OL33





OL33

Aluminium
Frosted tempered glass diffuser
IP65 / Class 1

SOURCES

LED 18W - 3000K warm white
LED 18W - 4500K neutral white
LED 28W - 3000K warm white
LED 28W - 4500K neutral white
E27 30W max Ø78 mm - H130 mm max

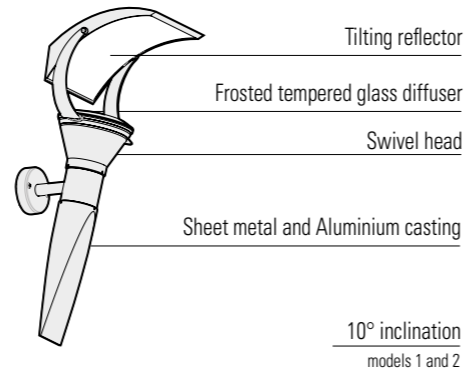

PRM Eav 20 lux p.304
Model 1

LED 2x28W	Pathway	Spacing
H 2,50 m	2,50 m	5,00 m

Model 6

LED 2x28W	Pathway	Spacing
H 3,30 m	3,00 m	8,00 m

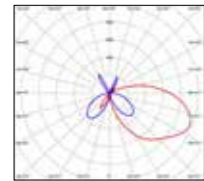

Models 2, 3 and 7

LED 18W
Real light output - 874 lm
CRI > 80

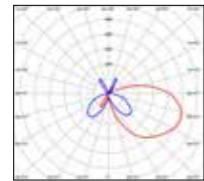

Models 1, 4 and 6

LED 28W
Real light output - 1223 lm
CRI > 80

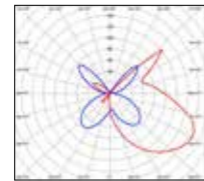

Models 1 to 7

E27 (1650 lm)
Real light output - 1088 lm

MODELS



H 695 . W 220 . D 363

1



H 432 . W 220 . D 363

2

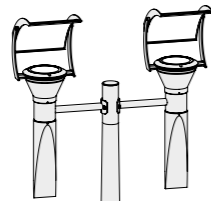

H 300 . W 728 . D 250

6

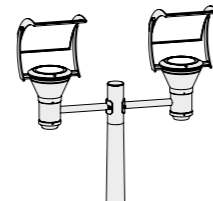

H 3300 . W 728 . D 250

7



H 486 . W 220 . D 249

3

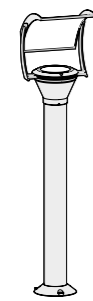

H 1035 . W 220 . D 249

4

REFERENCES

Replace ●●● with the colour code

MODELS

	E27	LED 18W 3000K warm white	LED 18W 4500K neutral white	LED 28W 3000K warm white	LED 28W 4500K neutral white
1	144 201 ●●●			144 202 ●●●	144 203 ●●●
2	144 204 ●●●	144 205 ●●●	144 206 ●●●		
3	144 207 ●●●	144 208 ●●●	144 209 ●●●		
4	144 210 ●●●			144 211 ●●●	144 212 ●●●
6	144 213 ●●●			144 214 ●●●	144 215 ●●●
7	144 216 ●●●	144 217 ●●●	144 218 ●●●		

COLOURS CODES

Replace ●●● with the colour code

■	RAL 7021 BLACK GREY	107
■	RAL 7044 SILK GREY	105
■	RAL 9010 PURE WHITE	101
■	OLD RUSTIC	046
■	RAL 3013 TOMATO RED	110
■	RAL 2004 PURE ORANGE	014

Other colours on request

MOUNTING

Wiring entry points in grey
Fixing kit included (except models 6 and 7)
Anchor bolts on request (models 6 and 7) p. 306

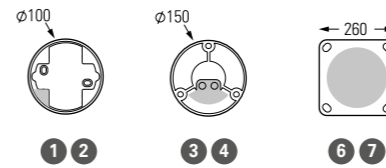

Ibuk

Design Stéphane Joyeux



Label VIA 2015



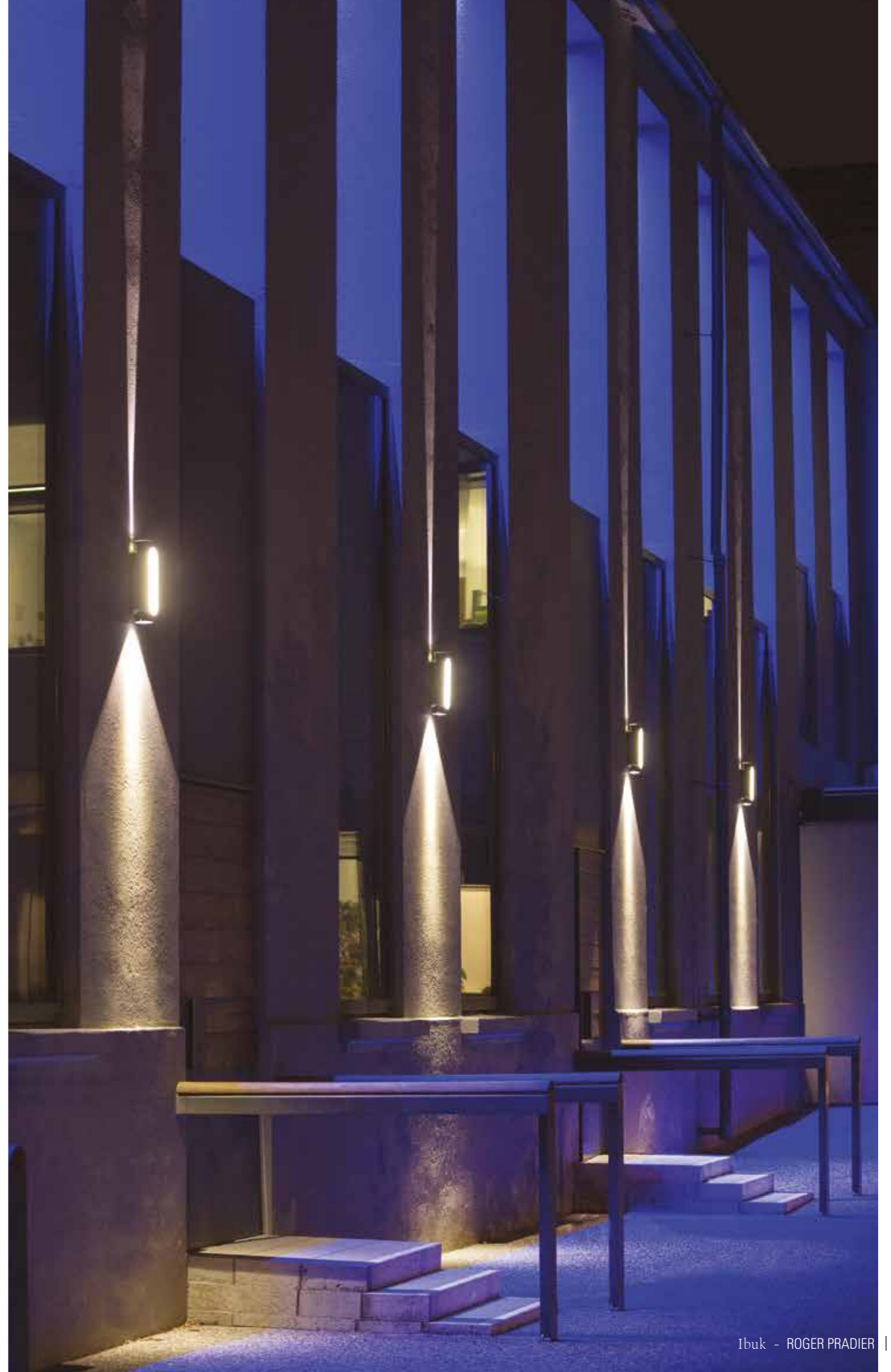

Ibuk

Aluminium
 Black or white polycarbonate front diffuser
 Clear polycarbonate Up & Down diffusers Ø80
 IP65 / IK10 / Class 2

SOURCES

LED 3x4,5W - 3000K warm white
 LED 3x4,5W - 4300K neutral white

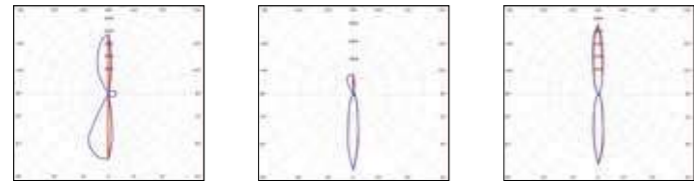
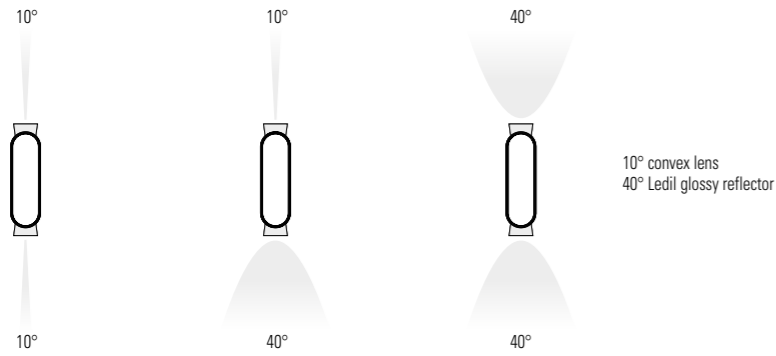

LED 3x4,5W - 10/10°
 Real light output - 307 lm
 CRI > 80

LED 3x4,5W - 10/40°
 Real light output - 630 lm
 CRI > 80

LED 3x4,5W - 40/40°
 Real light output - 980 lm
 CRI > 80

MODEL

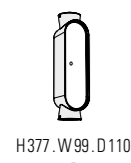

DIFFUSERS

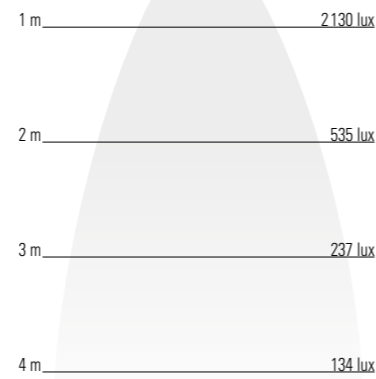
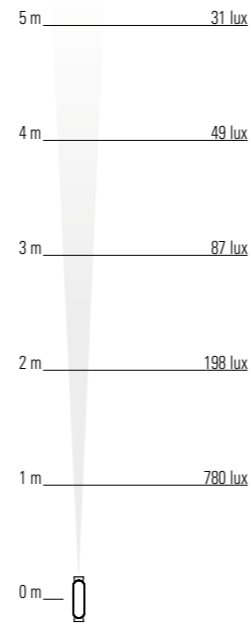
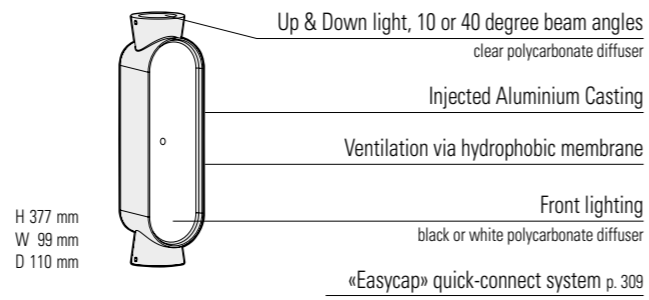
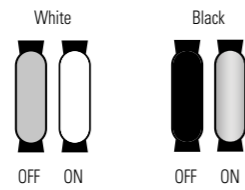

Ibuk

REFERENCES

Replace ●●● with the colour code

Warm white

MODEL	FRONT DIFFUSER	LED 3x4,5W - 10/10° 3000K warm white	LED 3x4,5W - 10/40° 3000K warm white	LED 3x4,5W - 40/40° 3000K warm white
1	WHITE POLYCARBONATE	126 001 ●●●	126 002 ●●●	126 003 ●●●
	BLACK POLYCARBONATE	126 004 ●●●	126 005 ●●●	126 006 ●●●

Neutral white

MODEL	FRONT DIFFUSER	LED 3x4,5W - 10/10° 4300K neutral white	LED 3x4,5W - 10/40° 4300K neutral white	LED 3x4,5W - 40/40° 4300K neutral white
1	WHITE POLYCARBONATE	126 007 ●●●	126 008 ●●●	126 009 ●●●
	BLACK POLYCARBONATE	126 010 ●●●	126 011 ●●●	126 012 ●●●

COLOURS CODES

Replace ●●● with the colour code

	RAL 7021 BLACK GREY 107		RAL 7044 SILK GREY 105
	RAL 9010 PURE WHITE 101		RAL 3005 WINE RED 066
	RAL 3013 TOMATO RED 110		RAL 3020 TRAFFIC RED 056
	RAL 2004 PURE ORANGE 014		RAL 1016 SULFUR YELLOW 068
	RAL 6025 FERN GREEN 109		VELVET BLACK 113
			DARK GREY 006
			BLUE 111
			SANDSTONE 054

Other colours on request

MOUNTING

Wiring entry point in grey
 Fixing kit included



Bamboo

Design Stéphane Joyeux

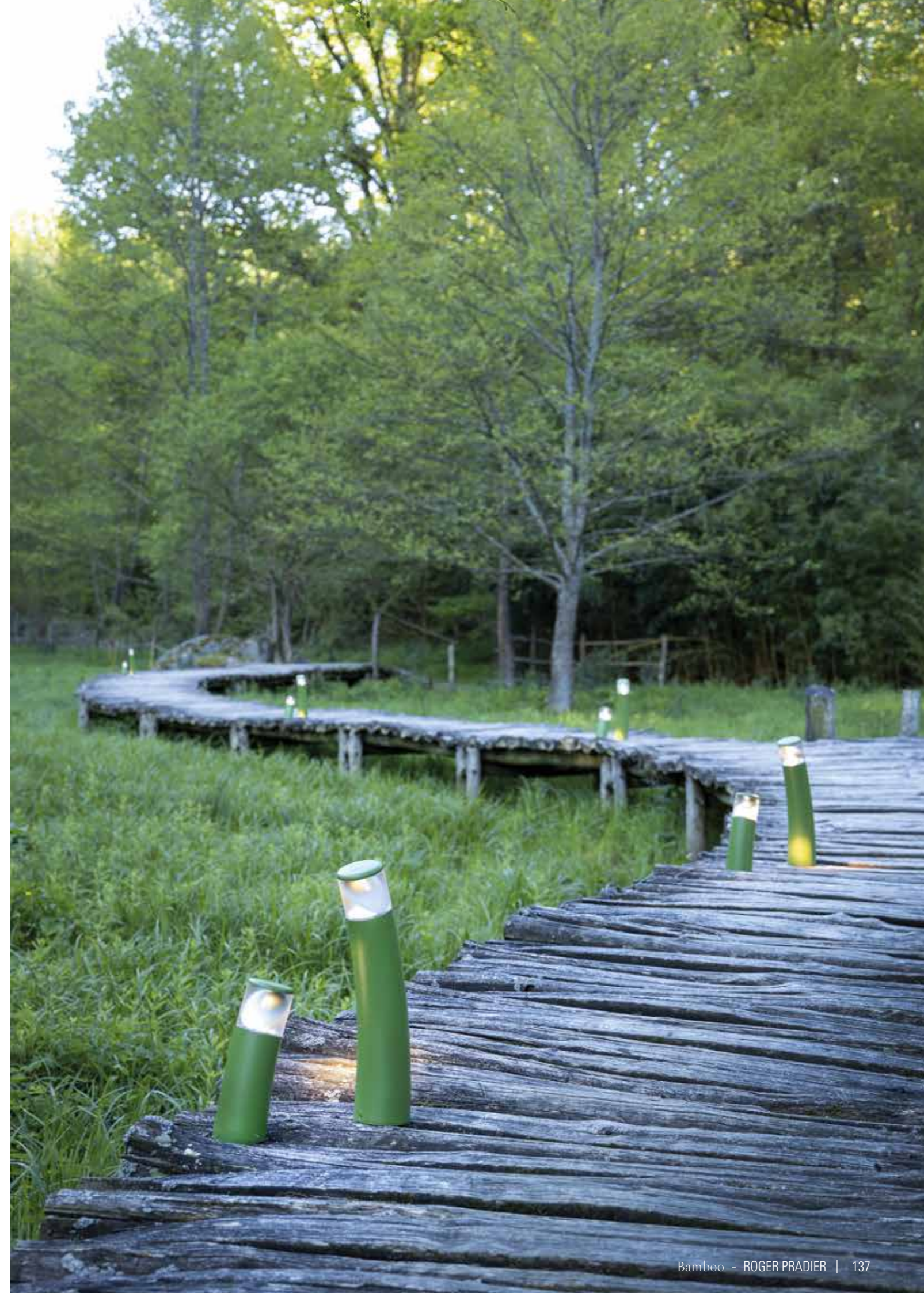

Bamboo

Aluminium
 Clear or opal satin-finish polycarbonate diffuser
 IP44 (models 1 and 2) / IP54 (model 3) on request / Class 1

SOURCE

GU10 PAR16 LED - 23W max H 80 mm max

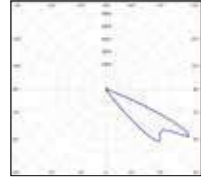

Models **1 to 3**

GU10 (575 lm)
 Real light output/clear - 487 lm

MODELS

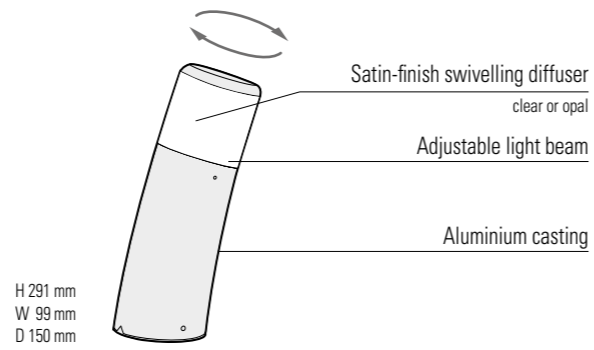

REFERENCES

Replace **•••** with the colour code

MODELS	DIFFUSERS	GU10 PAR16 LED
1	CLEAR POLYCARBONATE	105 001 •••
	OPAL POLYCARBONATE	105 002 •••
2	CLEAR POLYCARBONATE	105 003 •••
	OPAL POLYCARBONATE	105 004 •••
3	CLEAR POLYCARBONATE	105 005 •••
	OPAL POLYCARBONATE	105 006 •••
SPARE DIFFUSERS		
	CLEAR POLYCARBONATE	165 011 601
	OPAL POLYCARBONATE	165 011 602

MOUNTING

Wiring entry points in grey
 Fixing kit included

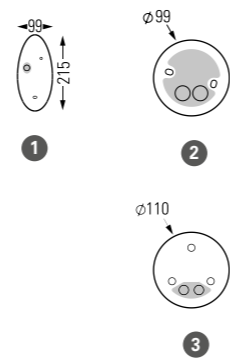

COLOURS CODES

Replace **•••** with the colour code

	DARK GREY 006		RAL 3020 TRAFFIC RED 056
	SLATE GREY 059		RAL 2004 PURE ORANGE 014
	RAL 7044 SILK GREY 105		RAL 6025 FERN GREEN 109
	RAL 9010 PURE WHITE 101		RAL 6018 YELLOW GREEN 015
	SANDSTONE 054	Other colours on request	
	OLD RUSTIC 046		



Bermude

Design Stéphane Joyeux



Bermude

Aluminium
Frosted glass diffuser
IP44 / Class 1

SOURCE

E27 - 105W max Ø68 mm - H180 mm max

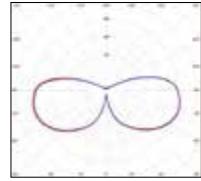

E27 (2450 lm)
Real light output - 1230 lm

PRM Eav 20 lux p.304
Model 5

E27 (2450lm)	Pathway	Spacing
H 2,20m	2,00m	3,00m

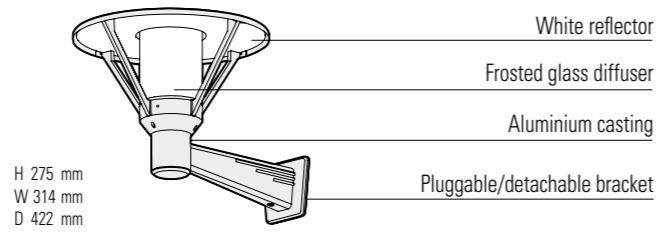

MODELS

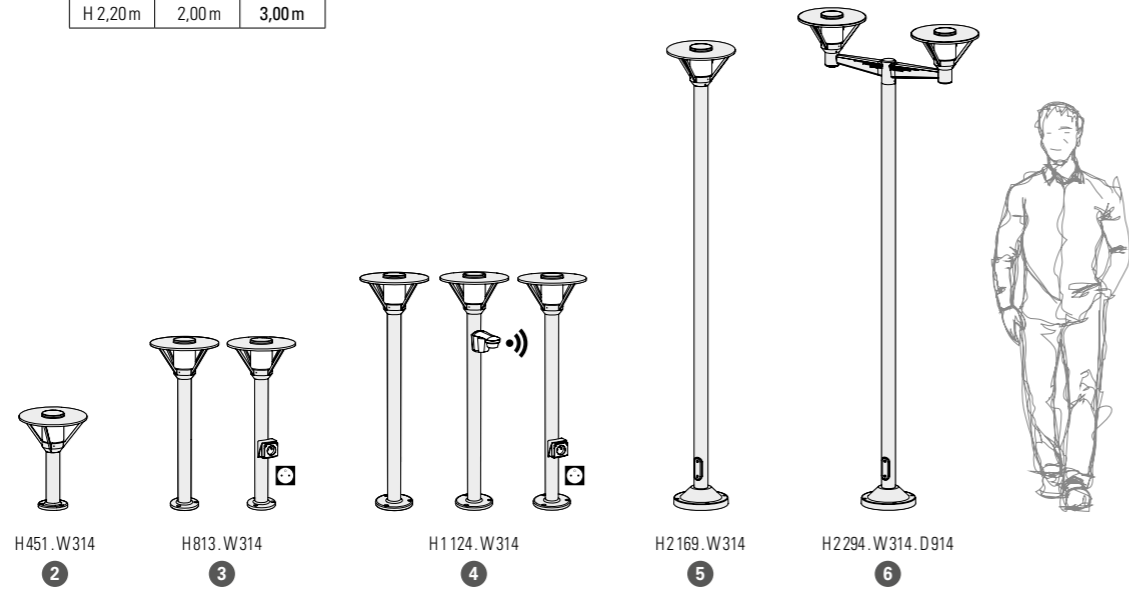
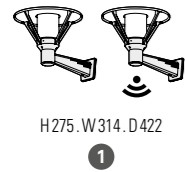

REFERENCES

Replace ●●● with the colour code / replace (●) with the country's electrical socket code

MODELS	E27	E27 + SENSOR	SOCKET	CORNER PLATE
1	115 001 ●●●	115 002 ●●●		147 006 ●●●
2	115 003 ●●●			
3	115 004 ●●●		115 005 ●●●(●)	
4	115 006 ●●●	115 007 ●●●	115 008 ●●●(●)	
5	115 009 ●●●			
6	115 010 ●●●			
SPARE DIFFUSER				
	165 019 ●●●			

COLOURS CODES

Replace ●●● with the colour code

	RAL 7021 BLACK GREY 107		OLD RUSTIC 046
	DARK GREY 006		RAL 6009 FIR GREEN 067
	RAL 7044 SILK GREY 105		RAL 5011 STEEL BLUE 065
	WHITE 001		BLUE 111

Other colours on request

MOUNTING

Wiring entry points in grey
Fixing kit included

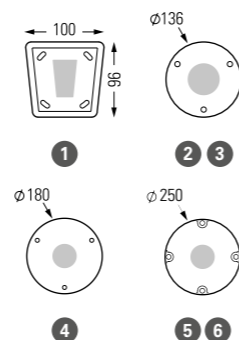

SOCKETS CODES

Except for French socket, replace (●) with country's socket code

	SCHUKO SOCKET SK type F		SWISS SOCKET CH type J
--	-------------------------	--	------------------------



Montana



Montana

Aluminium
Clear or frosted glass diffuser
IP44 / Class 1

SOURCE

E27 - 105W max Ø68 mm - H120 mm max

MODELS

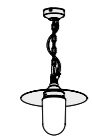

H 545 . W 282

1

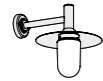

H 315 . W 282 . D 385

2

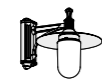

H 306 . W 282 . D 358

3

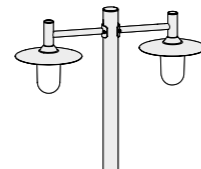

H 2 185 . W 827 . D 282

4



H 2 185 . W 827 . D 282

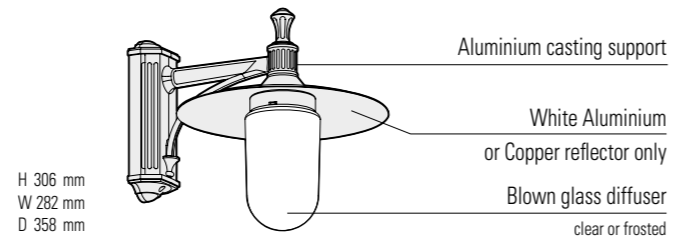

REFERENCES

Replace **•••** with the colour code

MODELS	DIFFUSERS	WHITE ALUMINIUM REFLECTOR E27	LACQUERED COPPER REFLECTOR E27	CORNER PLATES
1	CLEAR GLASS	139 001 •••	139 002 •••	
	FROSTED GLASS	139 003 •••	139 004 •••	
2	CLEAR GLASS	139 005 •••	139 006 •••	147 002 •••
	FROSTED GLASS	139 007 •••	139 008 •••	
3	CLEAR GLASS	139 009 •••	139 010 •••	147 004 •••
	FROSTED GLASS	139 011 •••	139 012 •••	
4	CLEAR GLASS	139 013 •••	139 014 •••	
	FROSTED GLASS	139 015 •••	139 016 •••	
SPARE DIFFUSERS				
	CLEAR GLASS	165 012 609		
	FROSTED GLASS	165 012 610		

COLOURS CODES

Replace **•••** with the colour code

	RAL 7021 BLACK GREY	107
	SLATE GREY	059
	WHITE	001
	RAL 5011 STEEL BLUE	065
	RAL 6009 BRITISH GREEN	019
	RAL 6009 FIR GREEN	067
	GREEN PATINA	008
	OLD RUSTIC	046
	RAL 3005 WINE RED	066

Other colours on request

MOUNTING

Wiring entry points in grey
Fixing kit included

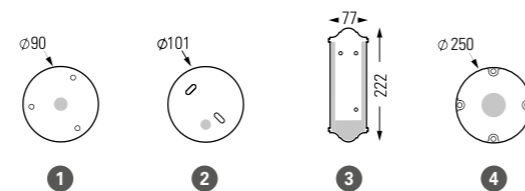

Kerlouan

Design Stéphane Joyeux



Kerlouan

Aluminium
Satin-finish polycarbonate diffuser
IP44 / Class 1

SOURCE

E27 - 105W max Ø66 mm - H145 mm max

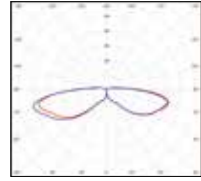

E27 (2450 lm)
Real light output - 493 lm

MODELS



H206 . W316 . D 405

1



H386 . W316

2

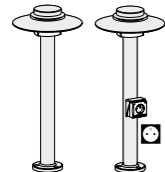

H750 . W316

3

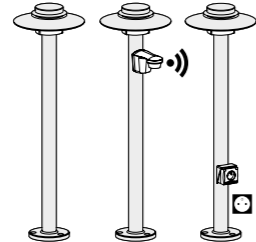

H1059 . W316

4

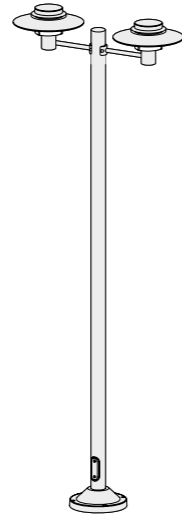

H2251 . W826 . D 316

6

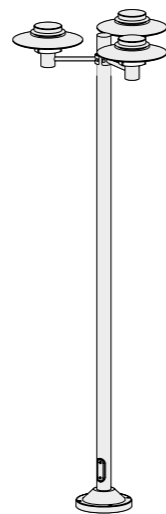

H2251 . W758

8

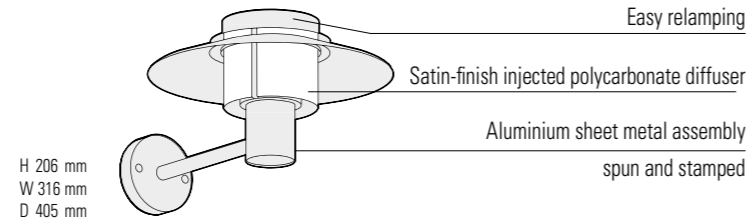

PRM Eav 20 lux p.304
Model 4

E27 (2450 lm)	Pathway	Spacing
H 1,10m	1,50m	3,00m

REFERENCES

Replace ●●● with the colour code / replace (●) with the country's electrical socket code

MODELS	E27	E27 + SENSOR	SOCKET	CORNER PLATE
1	128 001 ●●●			147 005 ●●●
2	128 002 ●●●			
3	128 003 ●●●		128 004 ●●●(●)	
4	128 005 ●●●	128 007 ●●●	128 006 ●●●(●)	
6	128 008 ●●●			
8	128 009 ●●●			
SPARE DIFFUSER				
165 031 601				

COLOURS CODES

Replace ●●● with the colour code

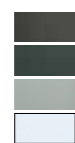

DARK GREY 006
SLATE GREY 059
METAL GREY 023
WHITE 001



RAL 6009 BRITISH GREEN 019
RAL 6009 FIR GREEN 067
RAL 5011 STEEL BLUE 065
OLD RUSTIC 046

Other colours on request

MOUNTING

Wiring entry points in grey
Fixing kit included

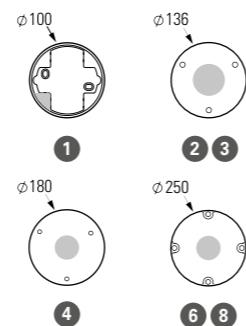

SOCKETS CODES

Except for French socket, replace (●) with country's socket code



SCHUKO SOCKET SK
type F

SWISS SOCKET CH
type J



Belcour

Design Stéphane Joyeux



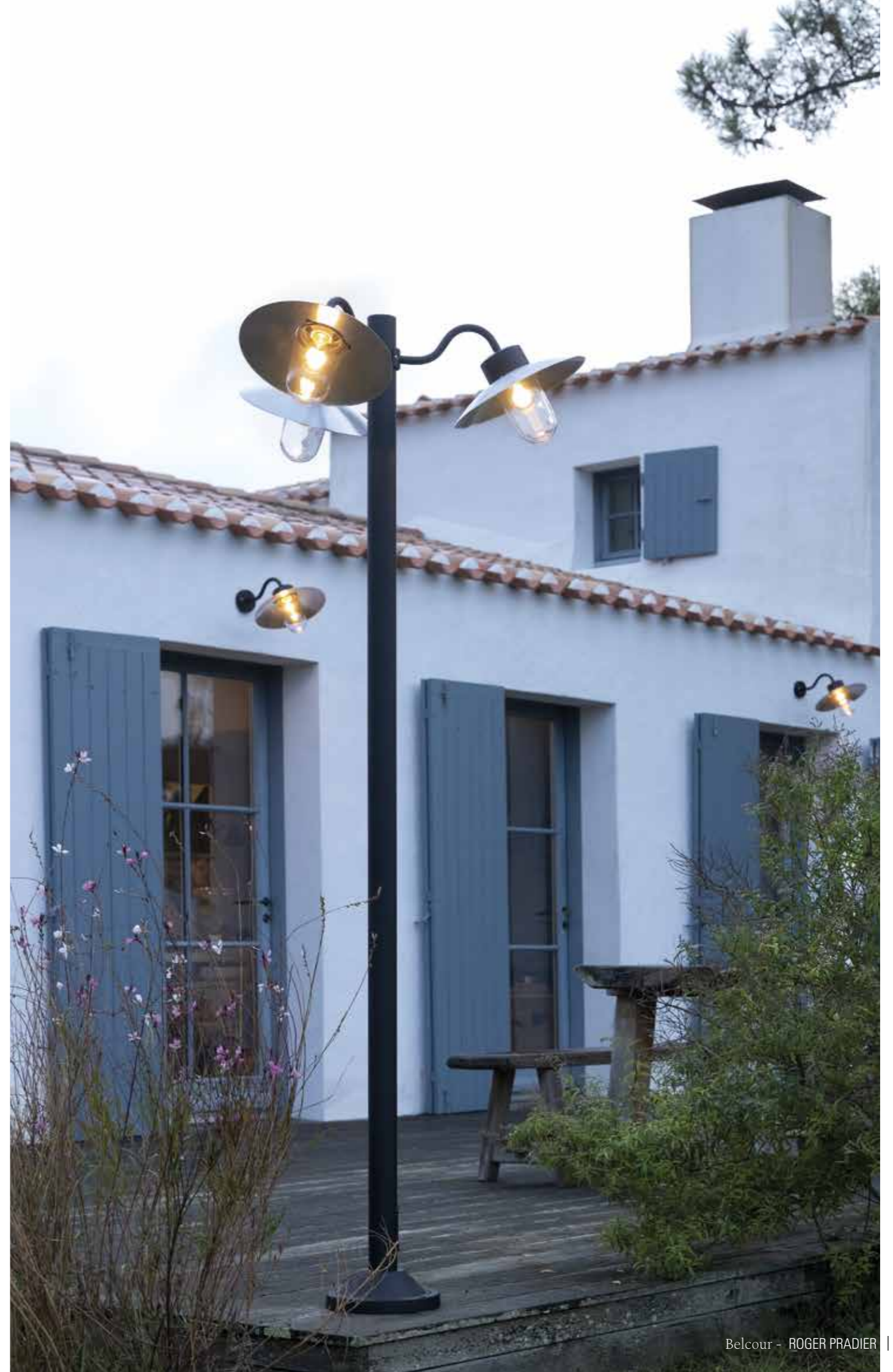

Belcour

Aluminium - Lacquered brushed copper - Brushed raw zinc
Clear or frosted glass diffuser
IP44 / Class 1

SOURCE

E27 - 60W max Ø 68 mm - H 160 mm max

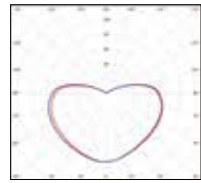

PRM Eav 20 lux p.304
Model 4

E27 (2450 lm)	Pathway	Spacing
H 2,20m	2,00m	6,00m

E27 (2450 lm)
Real light output/frosted - 1585 lm
Real light output/clear - 1583 lm

MODELS

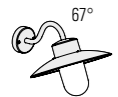

H267 . W320 . D419

1



H398 . W320

2



H295 . W320 . D421

8

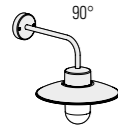

H385 . W320 . D466

9

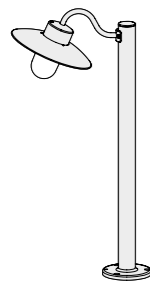

H1016 . W320 . D517

3

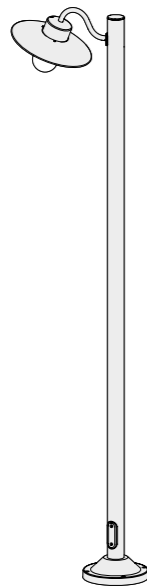

H2196 . W320 . D552

4

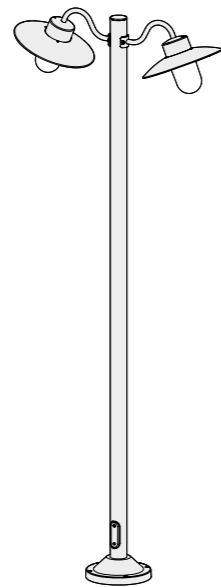

H2196 . W855 . D320

5

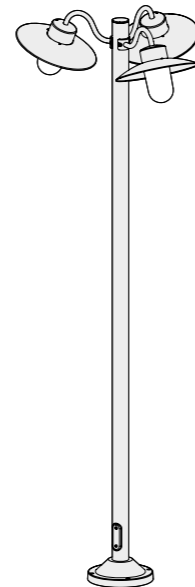

H2196 . W786

6

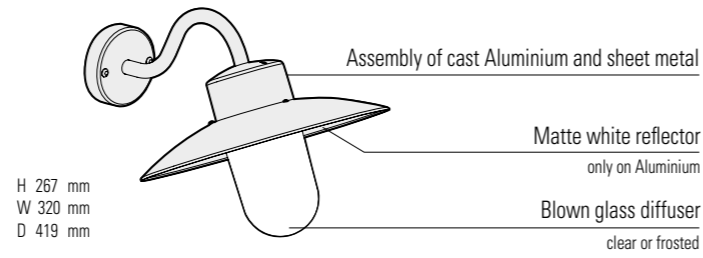

REFERENCES

Replace ... with the colour code or the material code

MODELS	DIFFUSERS	E27	CORNER PLATES
1	CLEAR GLASS	106 001 ...	147 005 ...
	FROSTED GLASS	106 002 ...	
2	CLEAR GLASS	106 003 ...	
	FROSTED GLASS	106 004 ...	
3	CLEAR GLASS	106 005 ...	
	FROSTED GLASS	106 006 ...	
4	CLEAR GLASS	106 007 ...	
	FROSTED GLASS	106 008 ...	
5	CLEAR GLASS	106 009 ...	
	FROSTED GLASS	106 010 ...	
6	CLEAR GLASS	106 011 ...	
	FROSTED GLASS	106 012 ...	
8	CLEAR GLASS	106 013 ...	147 005 ...
	FROSTED GLASS	106 014 ...	
9	CLEAR GLASS	106 015 ...	147 005 ...
	FROSTED GLASS	106 016 ...	
SPARE DIFFUSERS			
	CLEAR GLASS	165 035 609	
	FROSTED GLASS	165 035 610	

COLOURS CODES

Replace ... with the colour code

	RAL 9005 JET BLACK	000
	SLATE GREY	059
	METAL GREY	023
	WHITE	001
	OLD RUSTIC	046
	SANDSTONE	054
	RAL 6009 BRITISH GREEN	019
	RAL 6009 FIR GREEN	067
	RAL 6018 YELLOW GREEN	015
	RAL 3020 TRAFFIC RED	056
	RAL 5009 MATTE AZURE BLUE	134

Other colours on request

MATERIAL CODES

Replace ... with the material code

	LACQUERED BRUSHED COPPER	084
	BRUSHED RAW ZINC	092

With bracket and pole Velvet black 113 for all materials

MOUNTING

Wiring entry points in grey
Fixing kit included

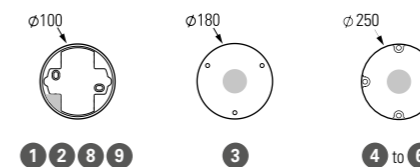

Aubanne

Design Stéphane Joyeux





Aubanne

Aluminium
Frosted or clear glass diffuser
Opal polycarbonate reflector
IP44 / Class 1

SOURCE

E27 - 23W max Ø 68mm - H 150mm max

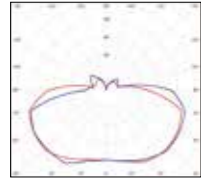

E27 (2450 lm)
Real light output/frosted - 1633 lm

MODELS

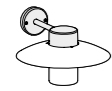

H 220 . W 328 . D 391
1



H 296 . W 328
2

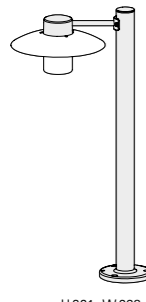

H 961 . W 328 . D 489
3

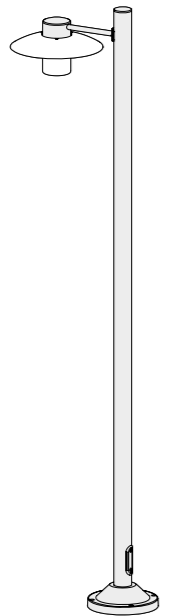

H 2185 . W 328 . D 559
4

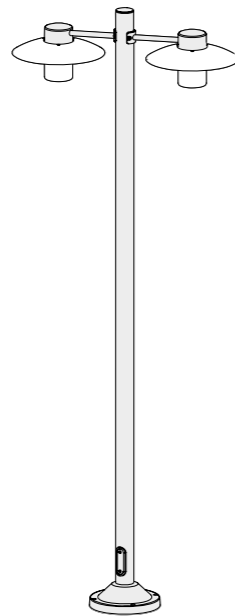

H 2185 . W 828 . D 328
5

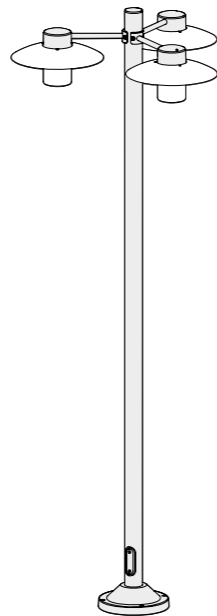

H 2185 . W 796
6

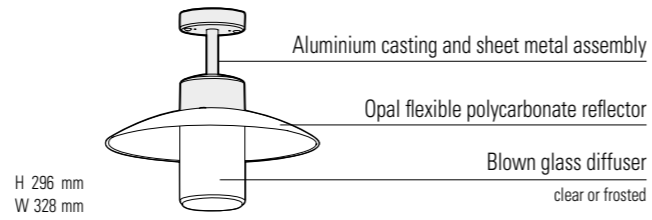

REFERENCES

Replace ●●● with the colour code

MODELS	DIFFUSERS	E27	CORNER PLATE
1	CLEAR GLASS	101 001 ●●●	147 005 ●●●
	FROSTED GLASS	101 002 ●●●	
2	CLEAR GLASS	101 003 ●●●	
	FROSTED GLASS	101 004 ●●●	
3	CLEAR GLASS	101 005 ●●●	
	FROSTED GLASS	101 006 ●●●	
4	CLEAR GLASS	101 007 ●●●	
	FROSTED GLASS	101 008 ●●●	
5	CLEAR GLASS	101 009 ●●●	
	FROSTED GLASS	101 010 ●●●	
6	CLEAR GLASS	101 011 ●●●	
	FROSTED GLASS	101 012 ●●●	
SPARE DIFFUSERS			
	CLEAR GLASS	165 001 609	
	FROSTED GLASS	165 001 610	

COLOURS CODES

Replace ●●● with the colour code ↴

	RAL 9010 PURE WHITE	101
	DARK GREY	006
	SLATE GREY	059
	METAL GREY	023
	SANDSTONE	054
	OLD RUSTIC	046
	RAL 5011 STEEL BLUE	065

Other colours on request

MOUNTING

Wiring entry points in grey
Fixing kit included

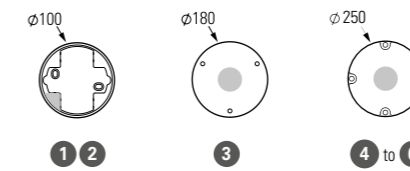

Newpark



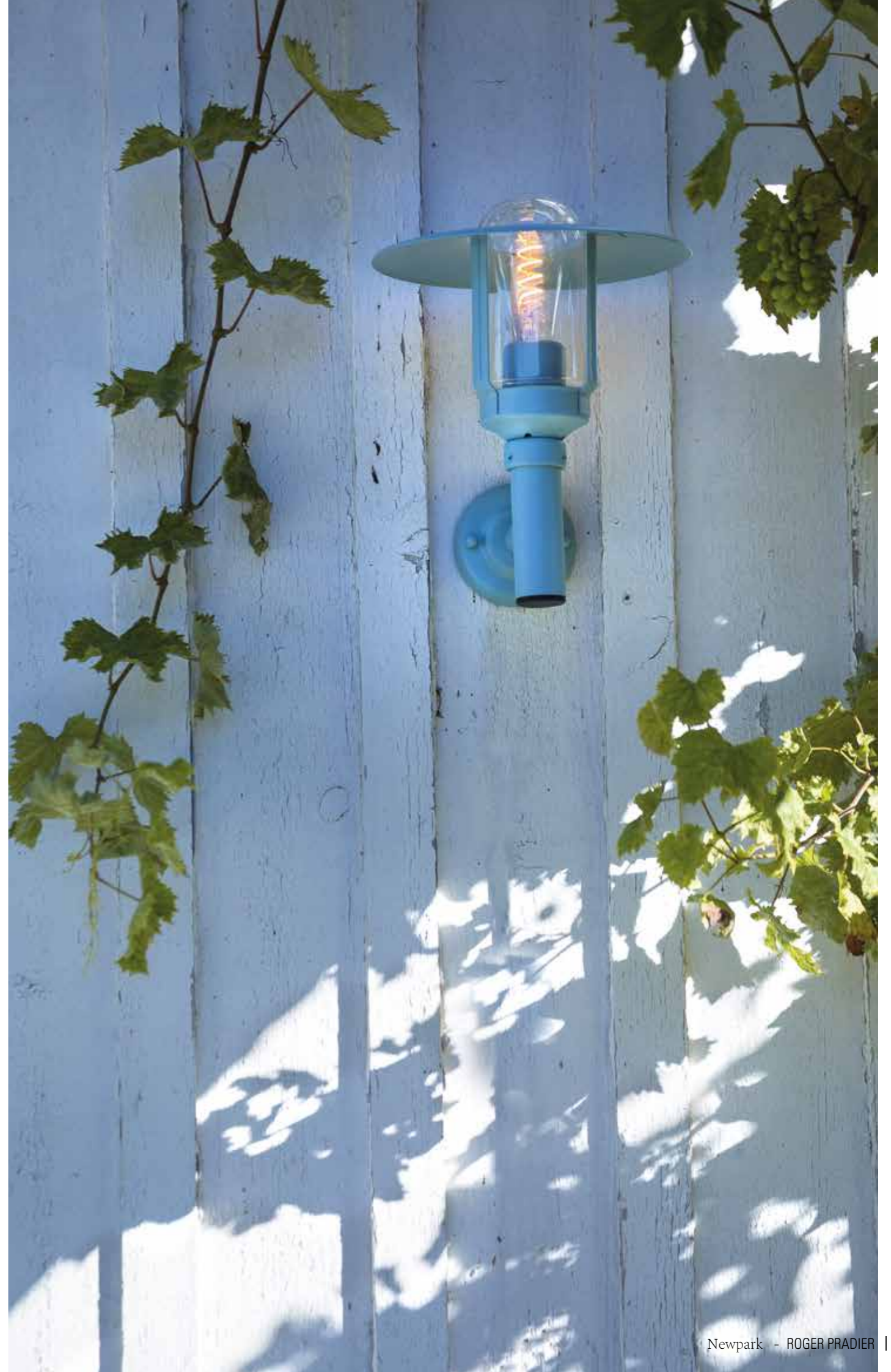

Newpark

Aluminium
Clear or frosted glass diffuser
IP44 / Class 1

SOURCE

E27 - 105W max Ø68 mm - H120 mm max

MODELS

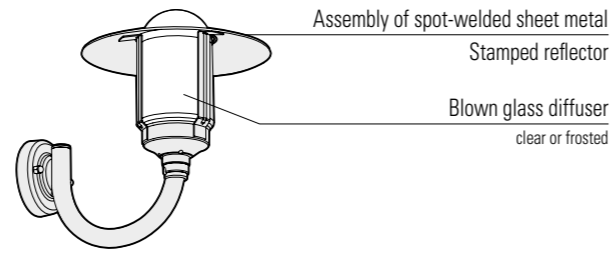
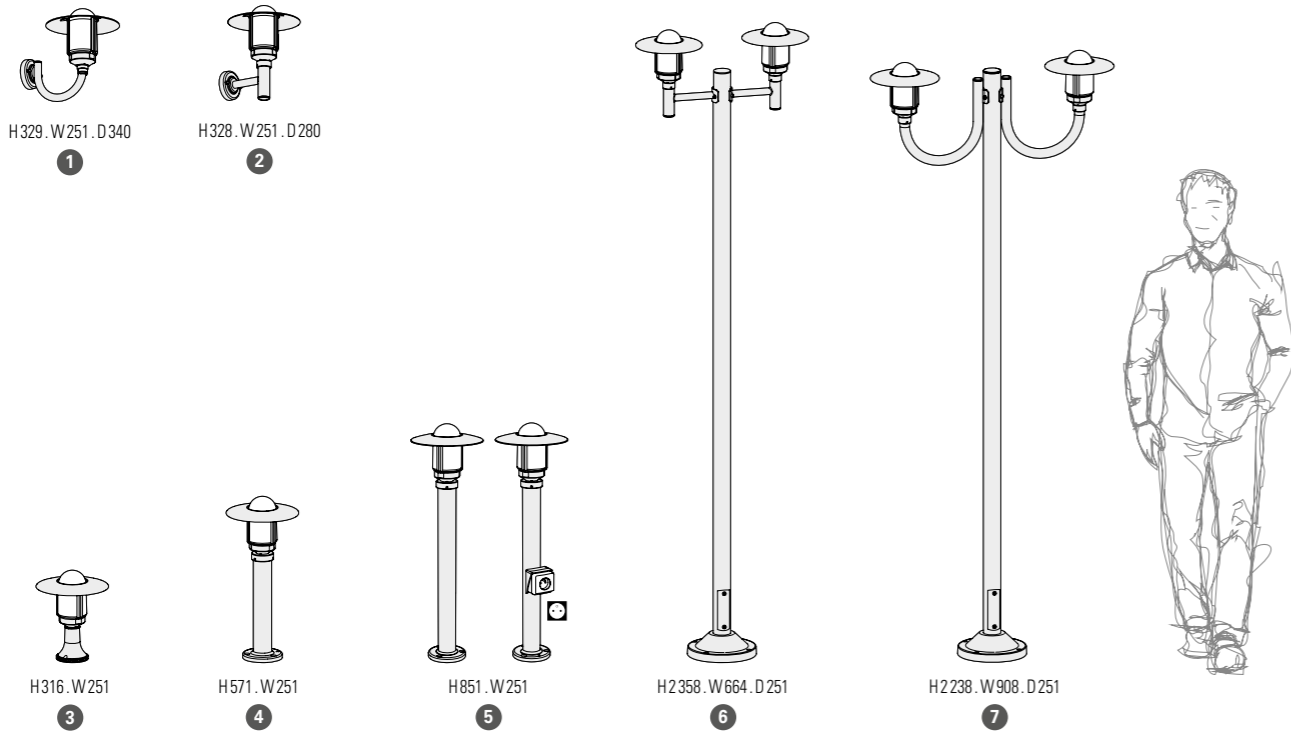

COLOURS CODES

Replace ●●● with the colour code ↓

Black	RAL 9005 JET BLACK	000
Dark Grey	SLATE GREY	059
Light Grey	METAL GREY	023
White	WHITE	001
Green	RAL 6009 BRITISH GREEN	019
Dark Green	RAL 6009 FIR GREEN	067
Red	RAL 3005 WINE RED	066
Blue	RAL 5011 STEEL BLUE	065
Light Blue	BLUE	111

Other colours on request

SOCKETS CODES

Except for French socket, replace (●) with country's socket code ↓

SCHUKO SOCKET SK type F
SWISS SOCKET CH type J

MOUNTING

Wiring entry points in grey
Fixing kit included

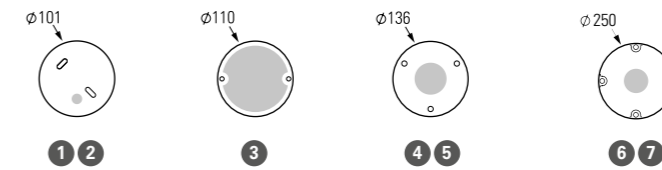

REFERENCES

Replace ●●● with the colour code / replace (●) with the country's electrical socket code

MODELS	DIFFUSERS	E27	SOCKET	CORNER PLATES
1	CLEAR GLASS	141 001 ●●●		147 002 ●●●
	FROSTED GLASS	141 002 ●●●		147 002 ●●●
2	CLEAR GLASS	141 003 ●●●		147 002 ●●●
	FROSTED GLASS	141 004 ●●●		147 002 ●●●
3	CLEAR GLASS	141 005 ●●●		
	FROSTED GLASS	141 006 ●●●		
4	CLEAR GLASS	141 007 ●●●		
	FROSTED GLASS	141 008 ●●●		
5	CLEAR GLASS	141 009 ●●●	141 010 ●●● (●)	
	FROSTED GLASS	141 011 ●●●	141 012 ●●● (●)	
6	CLEAR GLASS	141 013 ●●●		
	FROSTED GLASS	141 014 ●●●		
7	CLEAR GLASS	141 015 ●●●		
	FROSTED GLASS	141 016 ●●●		
SPARE DIFFUSERS				
	CLEAR GLASS	165 035 609		
	FROSTED GLASS	165 035 610		

Boléro



Boléro

Aluminium
Prismatic clear glass diffuser
IP23 / Class 1

SOURCE

E27 - 105W max H150 mm max

MODELS

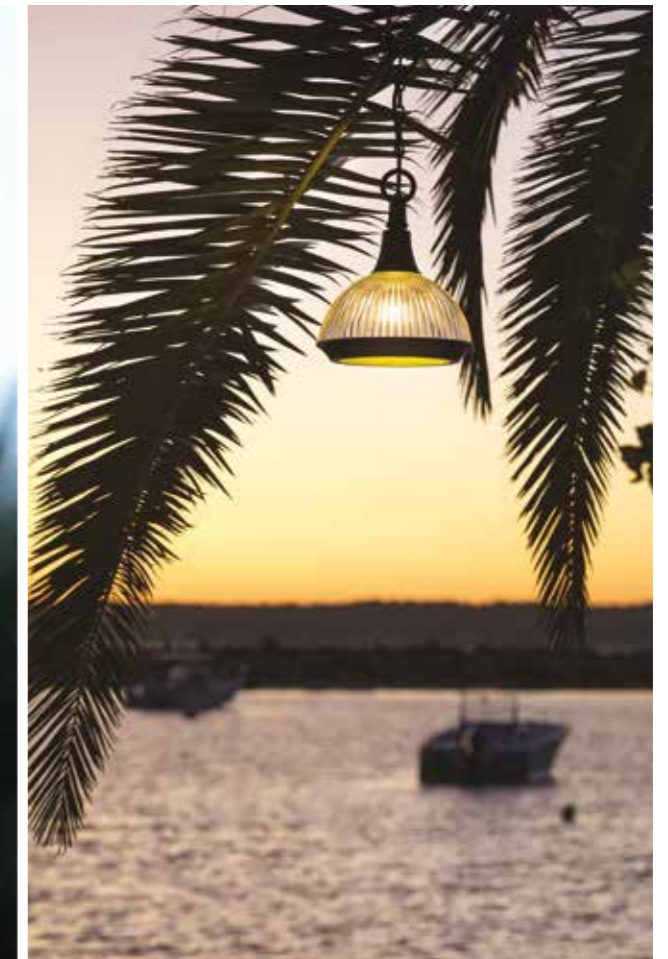
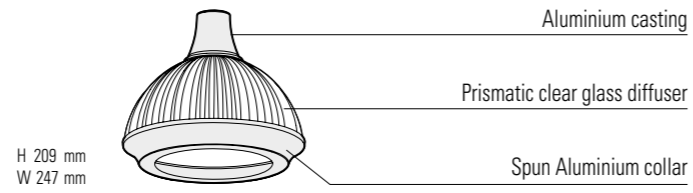
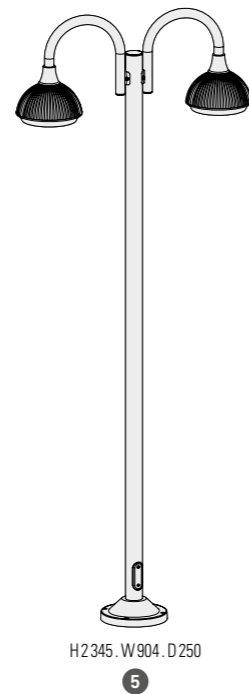

REFERENCES

Replace ●●● with the colour code

MODELS	E27	CORNER PLATES
1	152 001 ●●●	
2	152 002 ●●●	147 003 ●●●
3	152 003 ●●●	147 001 ●●●
5	152 004 ●●●	
SPARE DIFFUSER		
	165 059 ●●●	

MOUNTING

Wiring entry points in grey
Fixing kit included

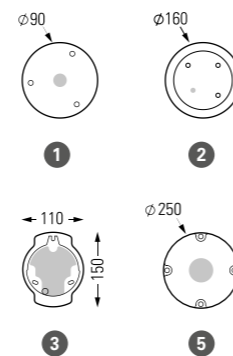

COLOURS CODES

Replace ●●● with the colour code

	RAL 9005 JET BLACK 000		RAL 6009 BRITISH GREEN 019
	SLATE GREY 059		RAL 6009 FIR GREEN 067
	WHITE 001		RAL 6025 FERN GREEN 109
	LIMESTONE 053		RAL 5011 STEEL BLUE 065

Other colours on request

Duo
—



Duo

Aluminium
Clear tempered glass diffuser
IP44 / Class 1

SOURCE

GU10 PAR16 LED - 2x23W max H 80 mm max

MODEL

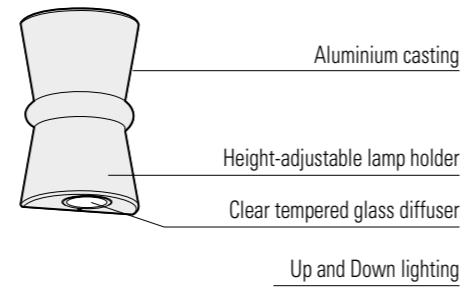

REFERENCE

Replace ●●● with the colour code

MODEL	GU10 PAR16 LED
1	120 001 ●●●

COLOURS CODES

Replace ●●● with the colour code

	DARK GREY 006		OLD RUSTIC 046
	SLATE GREY 059		SANDSTONE 054
	RAL 7044 SILK GREY 105		GOLD PATINA 009
	RAL 9010 PURE WHITE 101	Other colours on request	

MOUNTING

Wiring entry point in grey
Fixing kit included

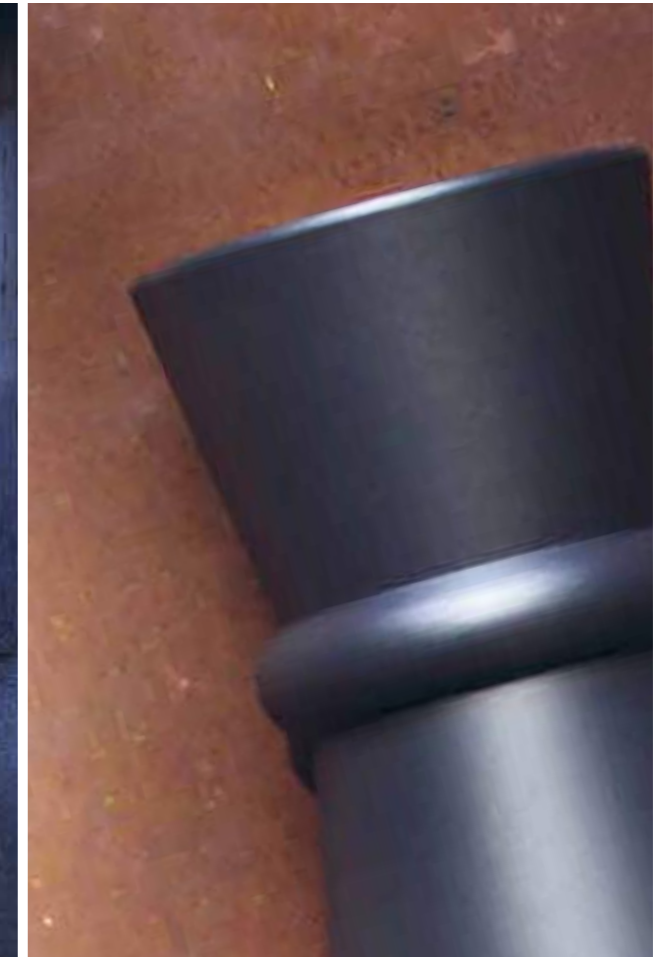
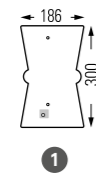

Dallas





Dallas

Aluminium
Opal or smoked polycarbonate diffuser
IP44 / IK10 / Class 1

SOURCE

E27 - 75W max H200 mm

MODELS

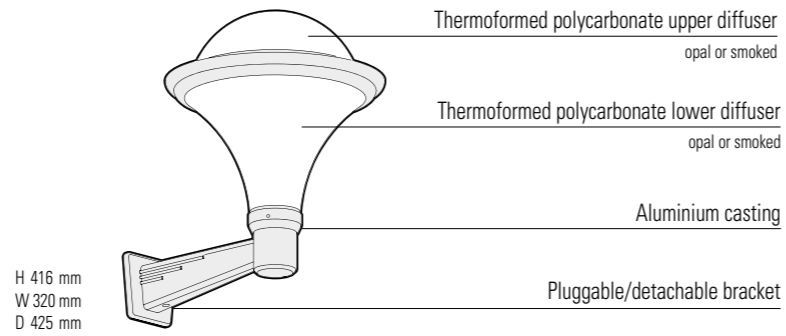

H 416 mm
W 320 mm
D 425 mm

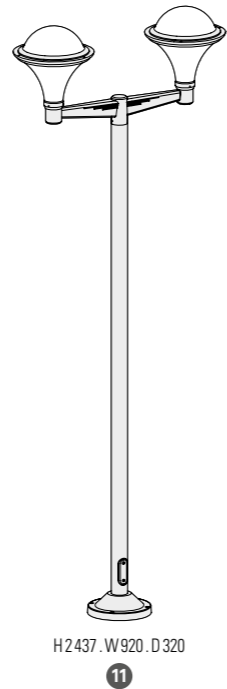
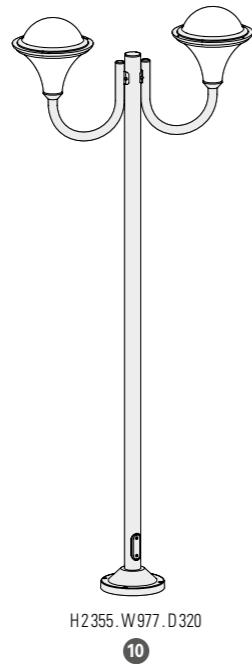
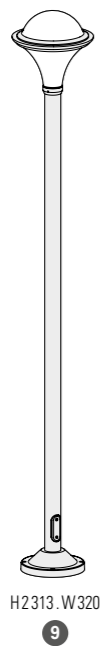
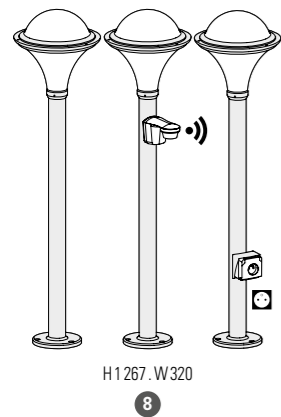
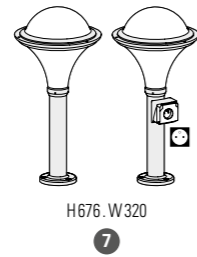

Dallas

REFERENCES

Replace ●●● with the colour code / replace (●) with the country's electrical socket code

MODELS	DIFFUSERS	E27	E27 + SENSOR	SOCKET	CORNER PLATES
1	OPAL POLYCARBONATE	119 001 ●●●			147 003 ●●●
	SMOKED POLYCARBONATE	119 002 ●●●			
2	OPAL POLYCARBONATE	119 003 ●●●	119 004 ●●●		147 006 ●●●
	SMOKED POLYCARBONATE	119 005 ●●●	119 006 ●●●		
3	OPAL POLYCARBONATE	119 021 ●●●			147 001 ●●●
	SMOKED POLYCARBONATE	119 022 ●●●			
4	OPAL POLYCARBONATE	119 023 ●●●			147 001 ●●●
	SMOKED POLYCARBONATE	119 024 ●●●			
5	OPAL POLYCARBONATE	119 025 ●●●			
	SMOKED POLYCARBONATE	119 026 ●●●			
6	OPAL POLYCARBONATE	119 027 ●●●			
	SMOKED POLYCARBONATE	119 028 ●●●			
7	OPAL POLYCARBONATE	119 007 ●●●		119 008 ●●●(●)	
	SMOKED POLYCARBONATE	119 009 ●●●		119 010 ●●●(●)	
8	OPAL POLYCARBONATE	119 011 ●●●	119 013 ●●●	119 012 ●●●(●)	
	SMOKED POLYCARBONATE	119 014 ●●●	119 016 ●●●	119 015 ●●●(●)	
9	OPAL POLYCARBONATE	119 029 ●●●			
	SMOKED POLYCARBONATE	119 030 ●●●			
10	OPAL POLYCARBONATE	119 017 ●●●			
	SMOKED POLYCARBONATE	119 018 ●●●			
11	OPAL POLYCARBONATE	119 019 ●●●			
	SMOKED POLYCARBONATE	119 020 ●●●			
SPARE UPPER DIFFUSERS					
	OPAL POLYCARBONATE	165 024 602			
	SMOKED POLYCARBONATE	165 024 603			
SPARE LOWER DIFFUSERS					
	OPAL POLYCARBONATE	165 073 602			
	SMOKED POLYCARBONATE	165 073 603			

COLOURS CODES

Replace ●●● with the colour code

	RAL 9005 JET BLACK 000		RAL 6009 BRITISH GREEN 019
	DARK GREY 006		RAL 6009 FIR GREEN 067
	SLATE GREY 059		RAL 5011 STEEL BLUE 065
	WHITE 001		RAL 5009 MATTE AZURE BLUE 134
	SANDSTONE 054	Other colours on request	

SOCKETS CODES

Except for French socket, replace (●) with country's socket code

	SCHUKO SOCKET SK		SWISS SOCKET CH
	type F		type J

MOUNTING

Wiring entry points in grey
Fixing kit included

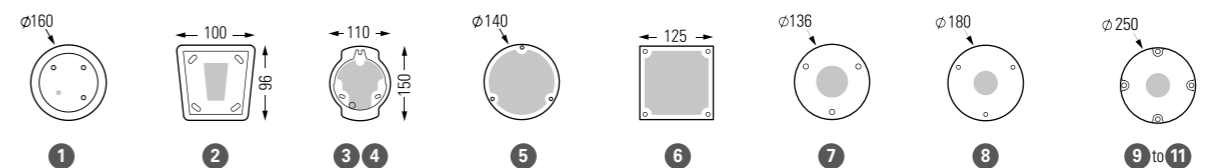

Trophy



Trophy

Aluminium
Ridged opal polycarbonate diffuser
IP44 / IK10 / Class 1

SOURCES

E27 - 40W max (model 1) Ø60 mm - H120 mm max
E27 - 60W max (model 3) Ø60 mm - H200 mm max

MODELS

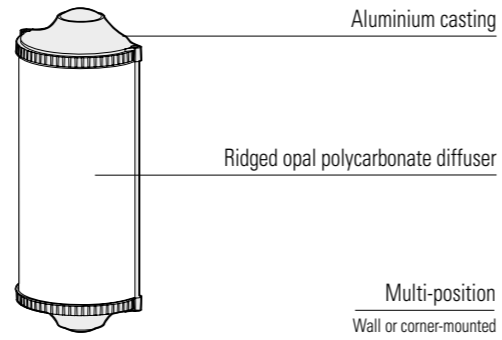
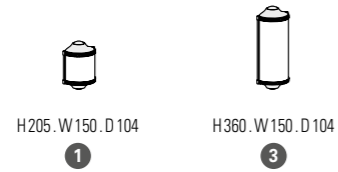

REFERENCES

Replace ●●● with the colour code

MODELS	E27	SPARE DIFFUSERS
1	161 001 ●●●	165 064 602
3	161 003 ●●●	165 065 602

COLOURS CODES

Replace ●●● with the colour code

	DARK GREY 006		OLD RUSTIC 046
	SLATE GREY 059		SANDSTONE 054
	RAL 7044 SILK GREY 105		LIMESTONE 053
	WHITE 001		RAL 3005 WINE RED 066

Other colours on request

MOUNTING

Wiring entry points in grey
Fixing kit included

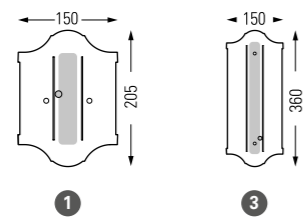

Moon





Moon

Aluminium
Opal or smoked Ø200 mm PMMA globe (models 1 to 4)
Opal Ø300 mm PMMA globe (models 5 to 13)
IP44 / IK08 / Class 1

SOURCES

E27 - 60W max (models 1 to 4) Ø 70 mm - H150 mm max
E27 - 105W max (models 5 to 13) Ø 80 mm - H200 mm max

MODELS Ø200 mm

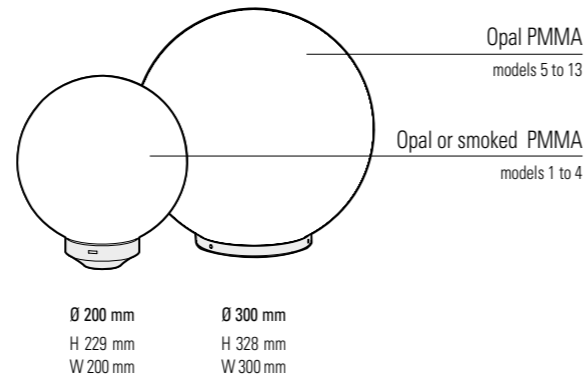
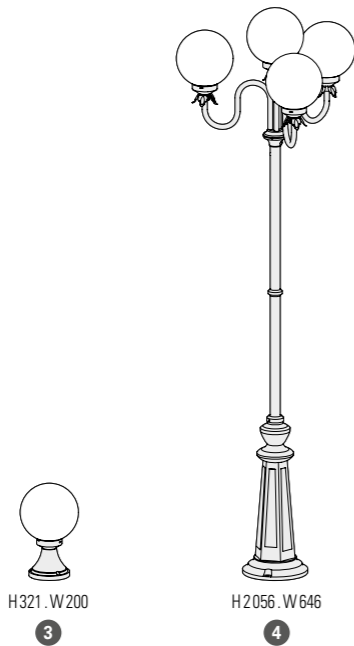
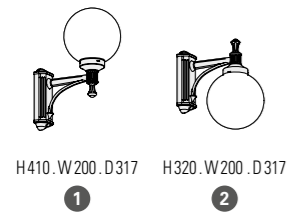

MODELS Ø300 mm

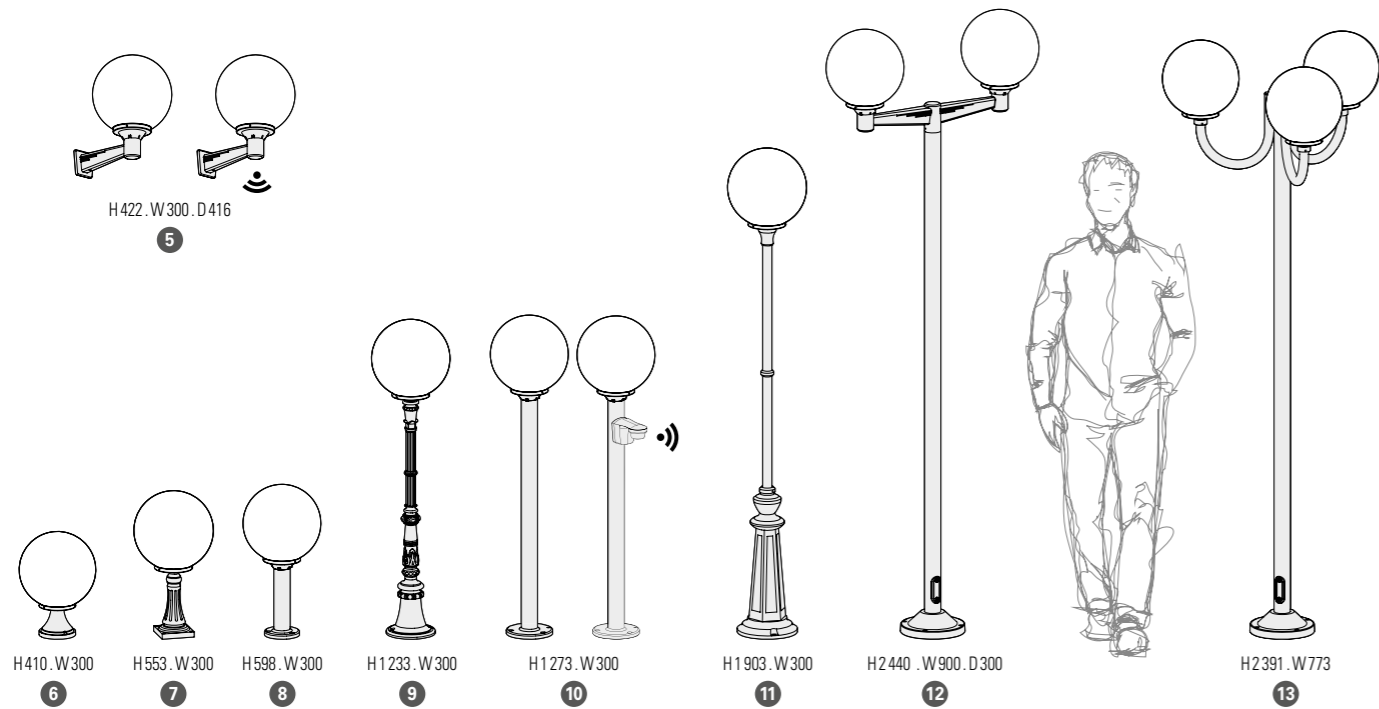

Moon

REFERENCES

Replace ... with the colour code

Ø 200 mm

MODELS	GLOBES	E27	CORNER PLATES
1	SMOKED PMMA	109 001 ...	147 004 ...
	OPAL PMMA	109 002 ...	
2	SMOKED PMMA	109 003 ...	147 004 ...
	OPAL PMMA	109 004 ...	
3	SMOKED PMMA	109 007 ...	
	OPAL PMMA	109 008 ...	
4	SMOKED PMMA	109 011 ...	
	OPAL PMMA	109 012 ...	
SPARE GLOBES			
	SMOKED PMMA	165 015 607	
	OPAL PMMA	165 015 606	

Ø 300 mm

MODELS	E27	E27 + SENSOR	CORNER PLATE
5	109 019 ...	109 020 ...	147 006 ...
6	109 013 ...		
7	109 014 ...		
8	109 017 ...		
9	109 016 ...		
10	109 021 ...	109 022 ...	
11	109 015 ...		
12	109 025 ...		
13	109 024 ...		
SPARE OPAL GLOBE			
		165 016 606	

COLOURS CODES

Replace ... with the colour code

	RAL 9005 JET BLACK 000		SANDSTONE 054
	SLATE GREY 059		LIMESTONE 053
	GREEN PATINA 008		RAL 6009 BRITISH GREEN 019
	WHITE 001		RAL 6009 FIR GREEN 067

Other colours on request

MOUNTING

Wiring entry points in grey
Fixing kit included

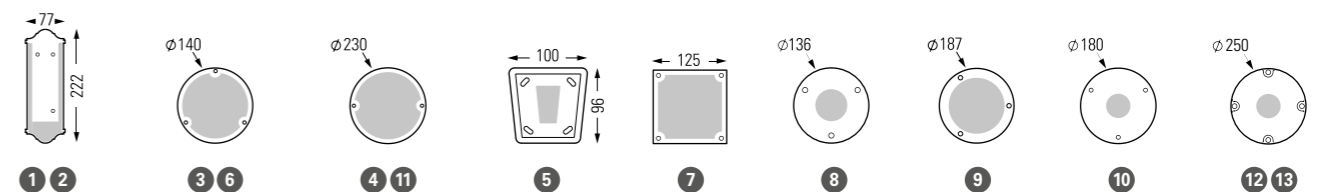

Boréal



Boréal

Aluminium
Opal or smoked Ø200 mm PMMA globe
IP44 / IK08 / Class 1

SOURCE

E27 - 60W max Ø 70 mm - H 150 mm max

MODELS

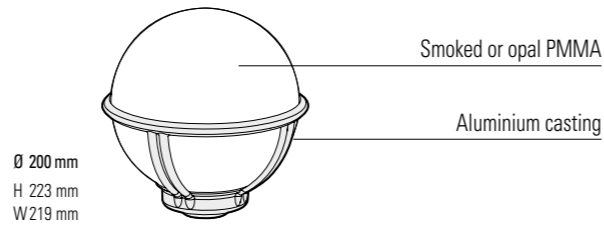
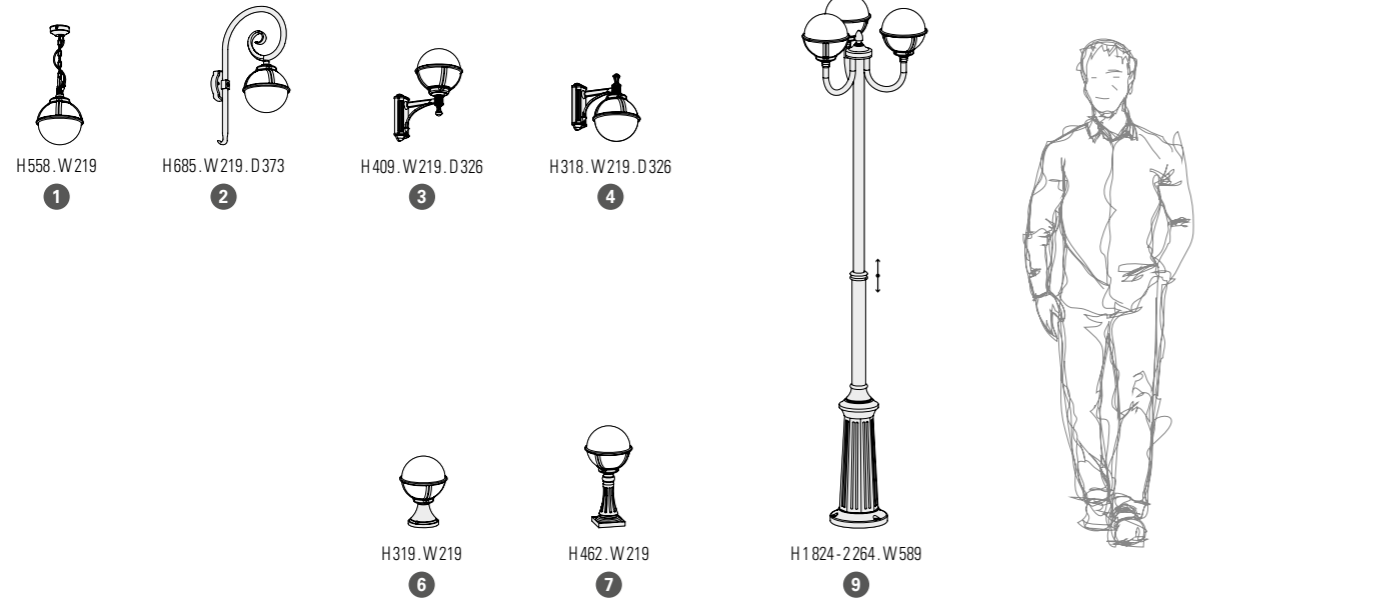

REFERENCES

Replace ●●● with the colour code

MODELS	GLOBES	E27	CORNER PLATES
1	OPAL PMMA	111 001 ●●●	
	SMOKED PMMA	111 002 ●●●	
2	OPAL PMMA	111 003 ●●●	147 001 ●●●
	SMOKED PMMA	111 004 ●●●	
3	OPAL PMMA	111 005 ●●●	147 004 ●●●
	SMOKED PMMA	111 006 ●●●	
4	OPAL PMMA	111 007 ●●●	147 004 ●●●
	SMOKED PMMA	111 008 ●●●	
6	OPAL PMMA	111 009 ●●●	
	SMOKED PMMA	111 010 ●●●	
7	OPAL PMMA	111 011 ●●●	
	SMOKED PMMA	111 012 ●●●	
9	OPAL PMMA	111 015 ●●●	
	SMOKED PMMA	111 016 ●●●	
SPARE GLOBES			
	OPAL PMMA	165 015 606	
	SMOKED PMMA	165 015 607	

MOUNTING

Wiring entry points in grey
Fixing kit included

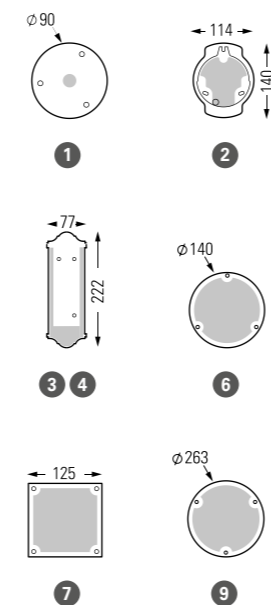

COLOURS CODES

Replace ●●● with the colour code

	RAL 9005 JET BLACK 000		RAL 6009 BRITISH GREEN 019
	METAL GREY 023		RAL 6009 FIR GREEN 067
	WHITE 001		GREEN PATINA 008
	OLD RUSTIC 046		GOLD PATINA 009

Other colours on request

Phoros

Design Stéphane Joyeux



Phoros

Aluminium
Clear polycarbonate diffuser
IP44 / IK09 / Class 1

SOURCE

E27 - 75W max Ø70 mm - H200 mm max

MODEL

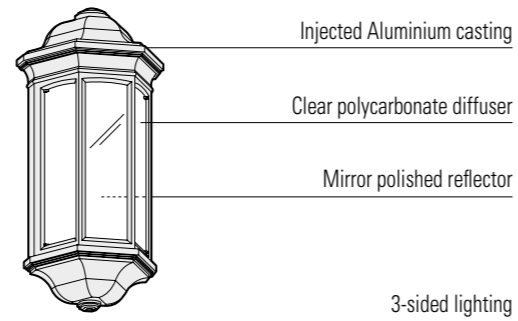

H 398 mm
W 190 mm
D 113 mm



REFERENCES

Replace ●●● with the colour code

MODEL	E27	SPARE DIFFUSER
1	145 001 ●●●	165 049 601

COLOURS CODES

Replace ●●● with the colour code

	RAL 9005 JET BLACK 000		LIMESTONE 053
	WHITE 101		GREEN PATINA 008
	OLD RUSTIC 046		GOLD PATINA 009

Other colours on request

MOUNTING

Wiring entry point in grey
Fixing kit included

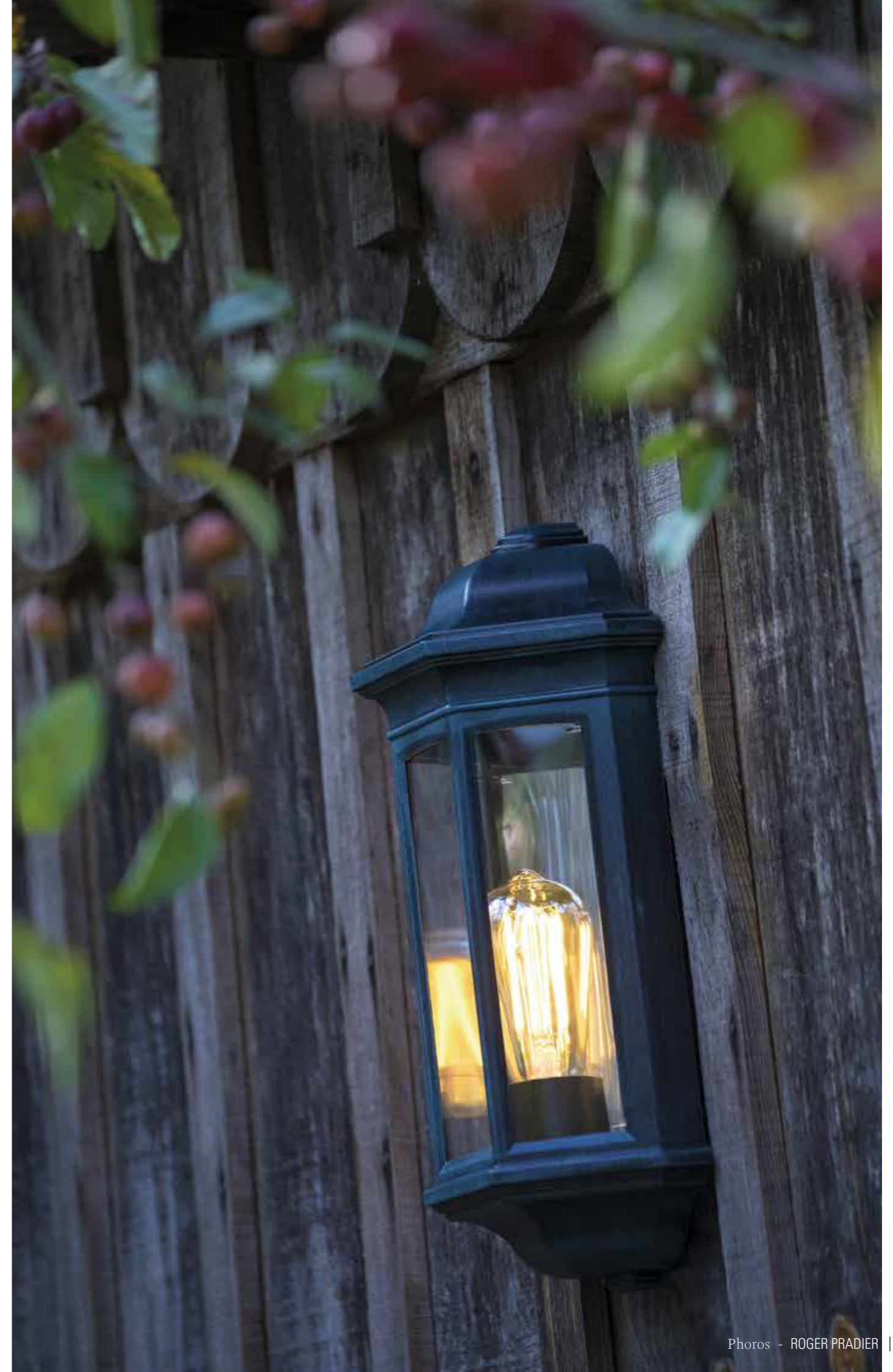
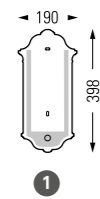

Monaco



Monaco

Aluminium
Clear glass diffuser
IP44 / Class 1

SOURCE

E27 - 60W max H 180 mm max

MODELS

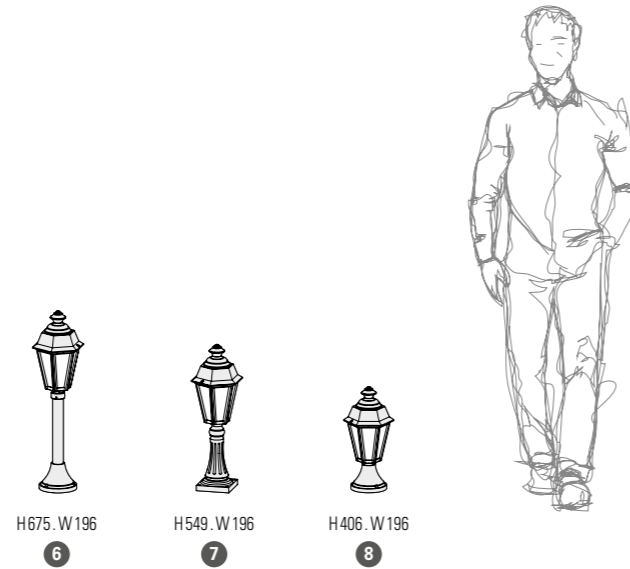
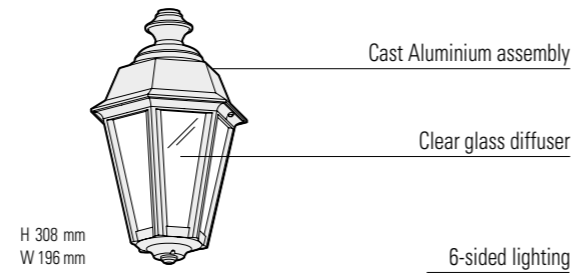
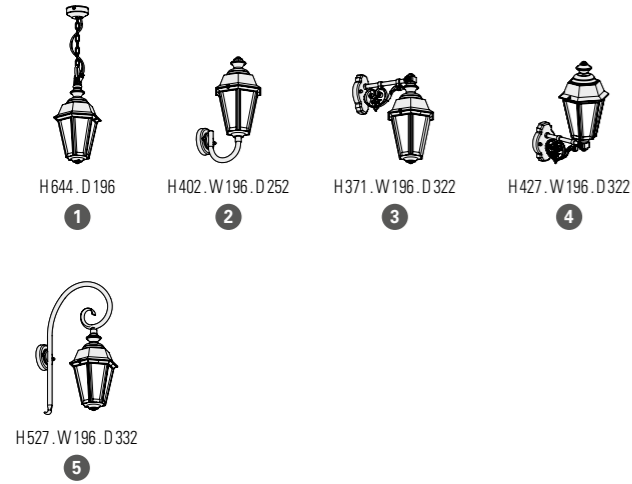

REFERENCES

Replace ... with the colour code

MODELS	E27	CORNER PLATE
1	138 001 ...	
2	138 002 ...	147 002 ...
3	138 003 ...	147 002 ...
4	138 004 ...	147 002 ...
5	138 005 ...	147 002 ...
6	138 006 ...	
7	138 007 ...	
8	138 008 ...	
SPARE DIFFUSER		
165 044 609		

COLOURS CODES

Replace ... with the colour code



MOUNTING

Wiring entry points in grey
Fixing kit included

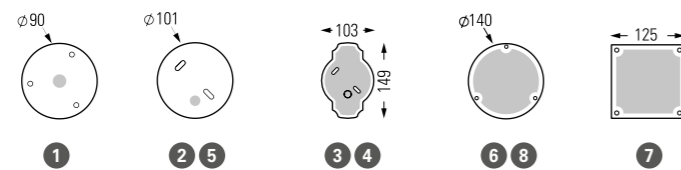

Louis Philippe 1

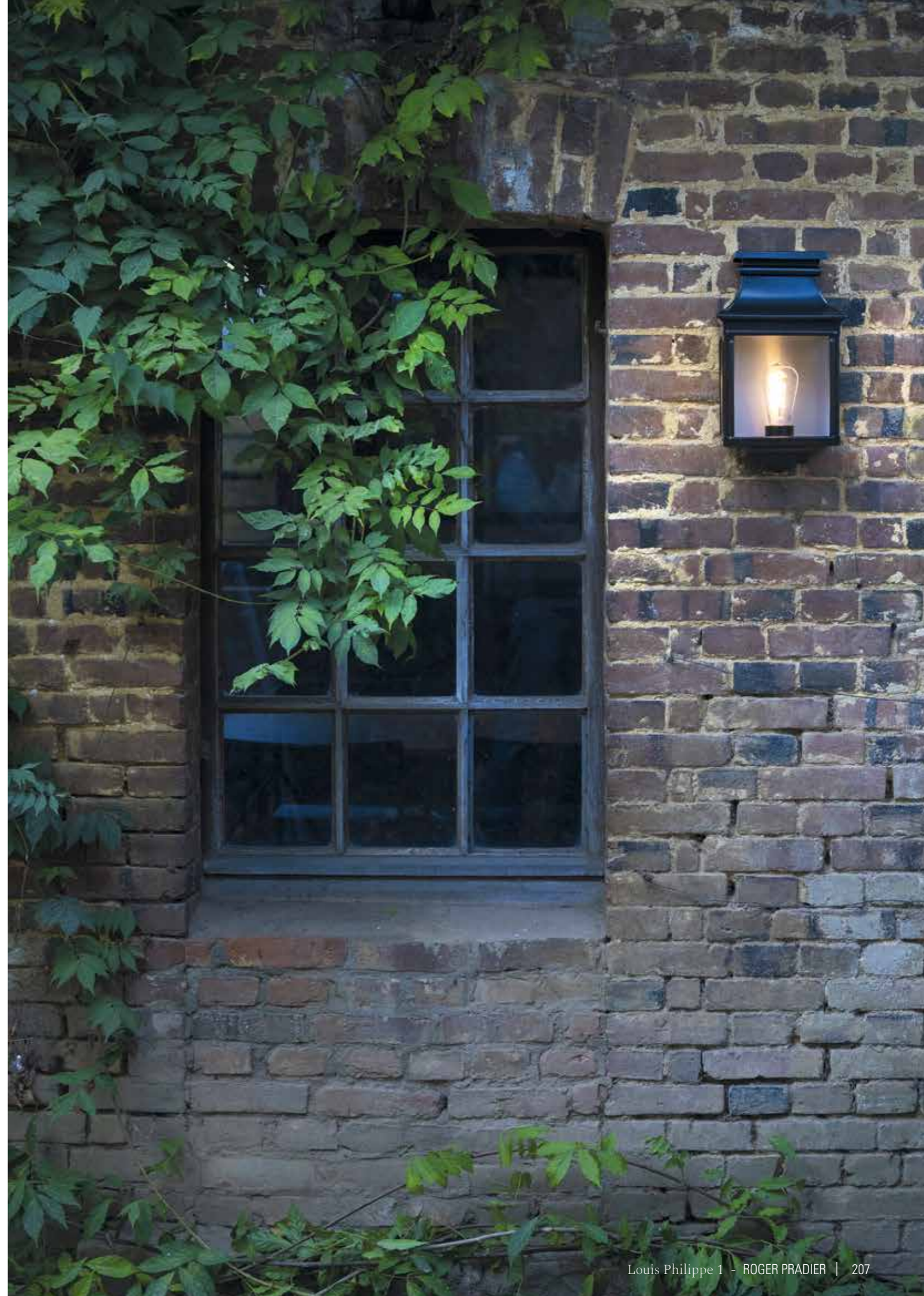

Louis Philippe 1

Aluminium - Tinted lacquered brass - Raw zinc
Clear glass diffuser
IP44 / Class 1

SOURCE

E27 - 75W max Ø 60 mm - H 200 mm max

MODEL

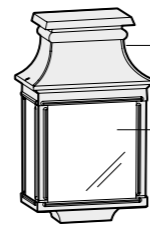

Assembly of spot-welded sheet metal

Clear glass diffuser

3-sided lighting

H 366 mm
W 222 mm
D 132 mm



REFERENCES

Replace ●●● with the colour code or the material code

MODEL	E27	SPARE DIFFUSER
1	134 001 ●●●	165 040 609

COLOURS CODES

Replace ●●● with the colour code

	RAL 9005 JET BLACK 000		OLD RUSTIC 046
	SLATE GREY 059		GREEN PATINA 008
	WHITE 001		GOLD PATINA 009
	SANDSTONE 054	Other colours on request	

MATERIAL CODES

Replace ●●● with the material code

	TINTED LACQUERED BRASS 070
	RAW ZINC 092

MOUNTING

Wiring entry point in grey
Fixing kit included

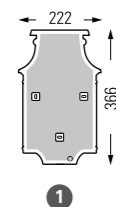

Louis Philippe 2



Louis Philippe 2

Aluminium - Tinted lacquered brass - Raw zinc
 Clear glass diffuser
 IP44 / Class 1

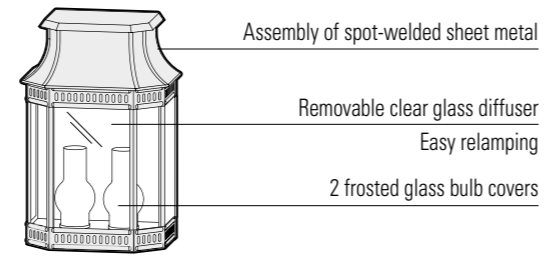

H 427 mm
 W 279 mm
 D 188 mm

SOURCES

E27 - 2x105W max Ø40 mm - H 130 mm max
 G9 - 2x75W max

MODEL



H 427 . W 279 . D 188

1



REFERENCES

Replace ●●● with the colour code or the material code

MODEL	E27	G9
1	135 001 ●●●	135 002 ●●●

SPARE DIFFUSERS

SPARE SET OF CLEAR GLASS	165 041 609
SPARE FROSTED GLASS BULB COVER	165 076 610

COLOURS CODES

Replace ●●● with the colour code

	RAL 9005 JET BLACK 000		OLD RUSTIC 046
	SLATE GREY 059		RAL 6009 FIR GREEN 067
	WHITE 001		GREEN PATINA 008
	SANDSTONE 054		GOLD PATINA 009

Other colours on request

MATERIAL CODES

Replace ●●● with the material code

	TINTED LACQUERED BRASS 070
	RAW ZINC 092

MOUNTING

Wiring entry point in grey
 Fixing kit included

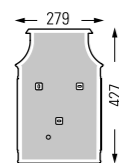

1



Louis Philippe 7

Design Stéphane Joyeux

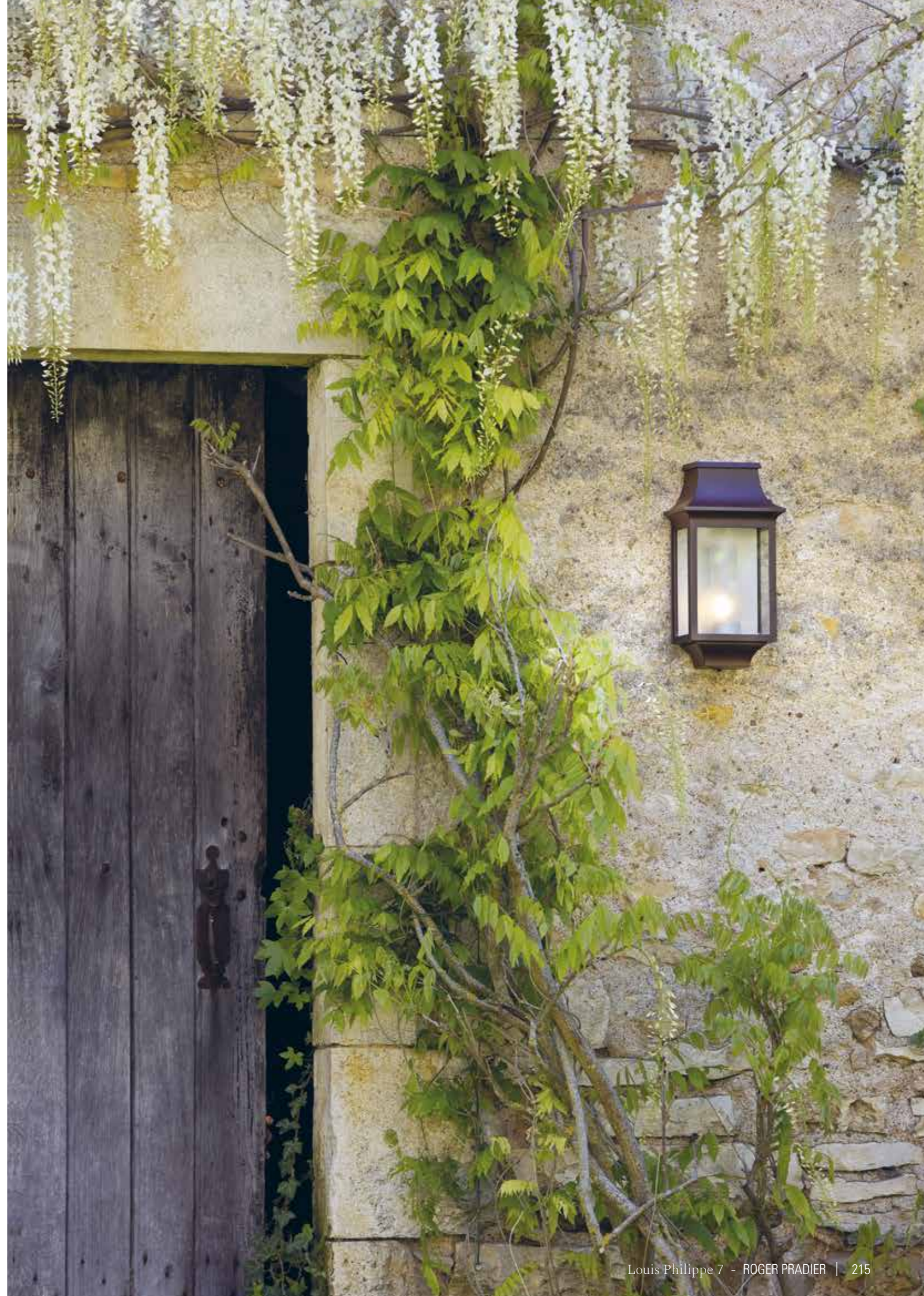

Louis Philippe 7

Aluminium
Clear glass diffuser
IP44 / Class 2

SOURCES

E27 - 23W max Ø 40 mm - H 160 mm max
G9 - 40W max

MODEL

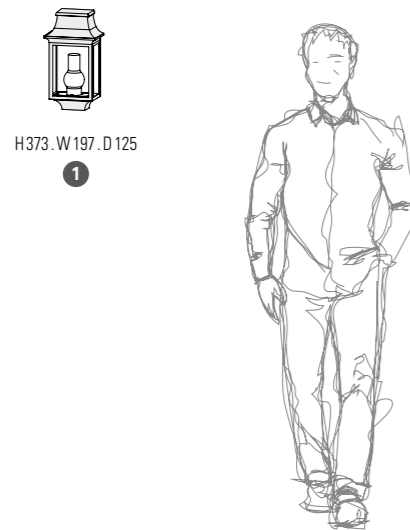

H 373 mm
W 197 mm
D 125 mm

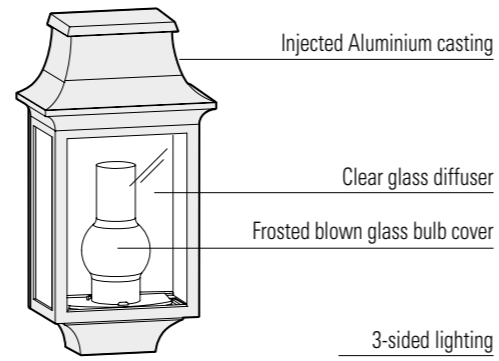

REFERENCES

Replace ●●● with the colour code

MODEL	E27	G9
1	136 001 ●●●	136 002 ●●●
SPARE DIFFUSERS		
SPARE SET OF CLEAR GLASS	165 042 609	
SPARE FROSTED GLASS BULB COVER	165 076 610	

COLOURS CODES

Replace ●●● with the colour code

	RAL 9005 JET BLACK 000		OLD RUSTIC 046
	SLATE GREY 059		GREEN PATINA 008
	WHITE 001		GOLD PATINA 009
	SANDSTONE 054	Other colours on request	

MOUNTING

Wiring entry point in grey
Fixing kit included

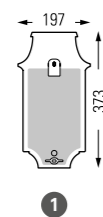

Vieille France

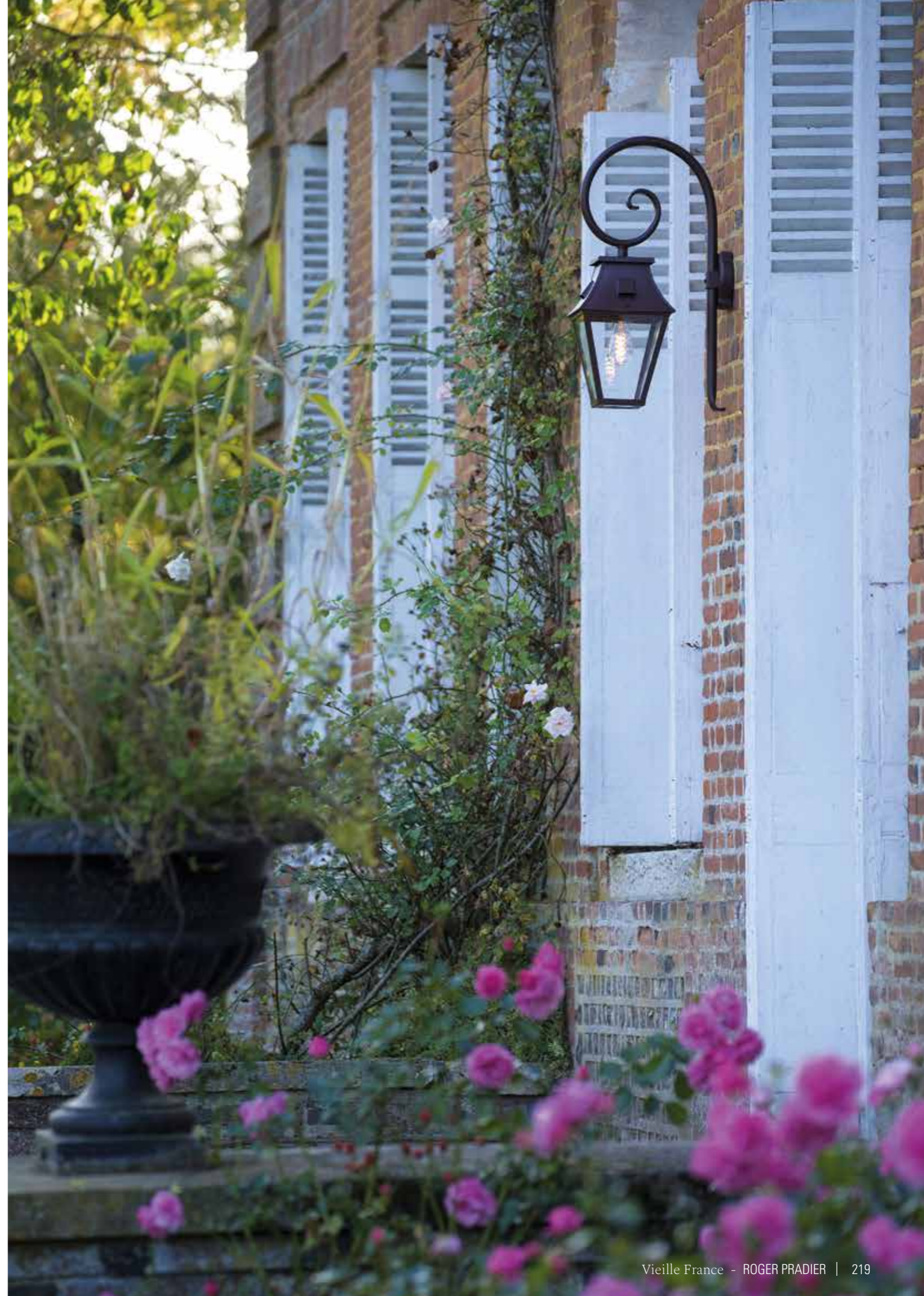

Vieille France

Aluminium - Tinted lacquered brass - Raw zinc (model 2)
 Clear glass diffuser
 IP44 / Class 1

SOURCES

E27 - 105W max (except model 2) H 200 mm max
 E27 - 75W max (model 2) Ø66 mm - H 120 mm max

MODELS

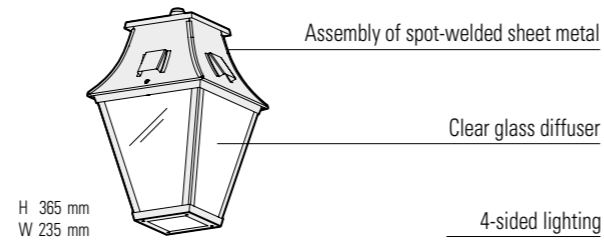
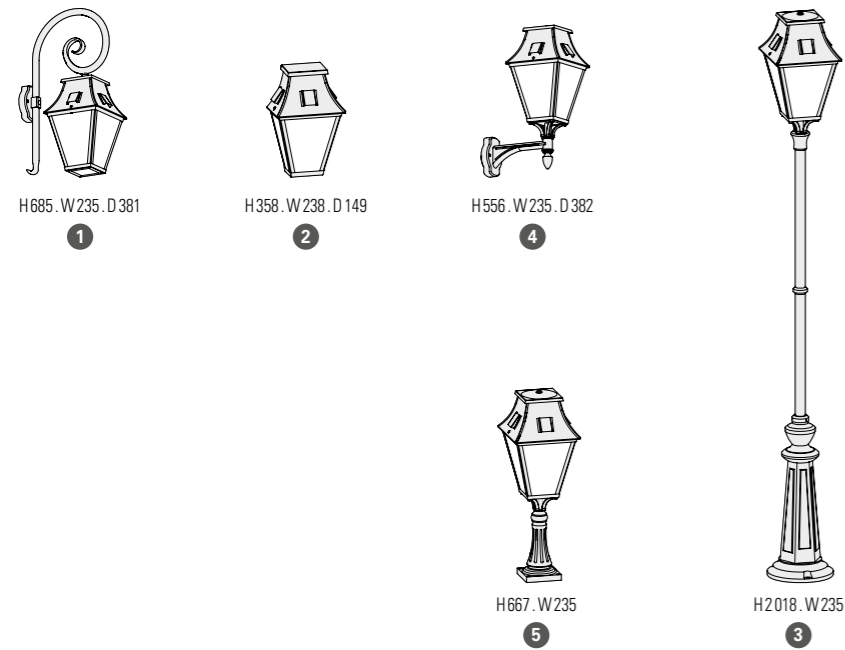

REFERENCES

Replace **•••** with the colour code or the material code

MODELS	E27	CORNER PLATE
1	163 001 •••	147 001 •••
2	163 002 •••	
3	163 003 •••	
4	163 004 •••	147 001 •••
5	163 005 •••	
SPARE DIFFUSER		
	165 067 609 (model 2)	
	165 068 609	

COLOURS CODES

Replace **•••** with the colour code

	RAL 9005 JET BLACK	000
	OLD RUSTIC	046
	SANDSTONE	054
	GREEN PATINA	008

Other colours on request

MATERIAL CODES

Replace **•••** with the material code

	TINTED LACQUERED BRASS	070	Aluminium base Jet black 000
	RAW ZINC	092	(model 2)

MOUNTING

Wiring entry points in grey
 Fixing kit included

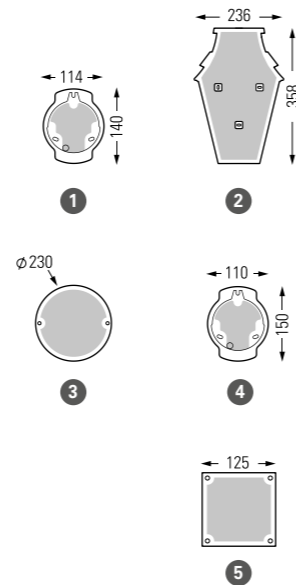

Louvre

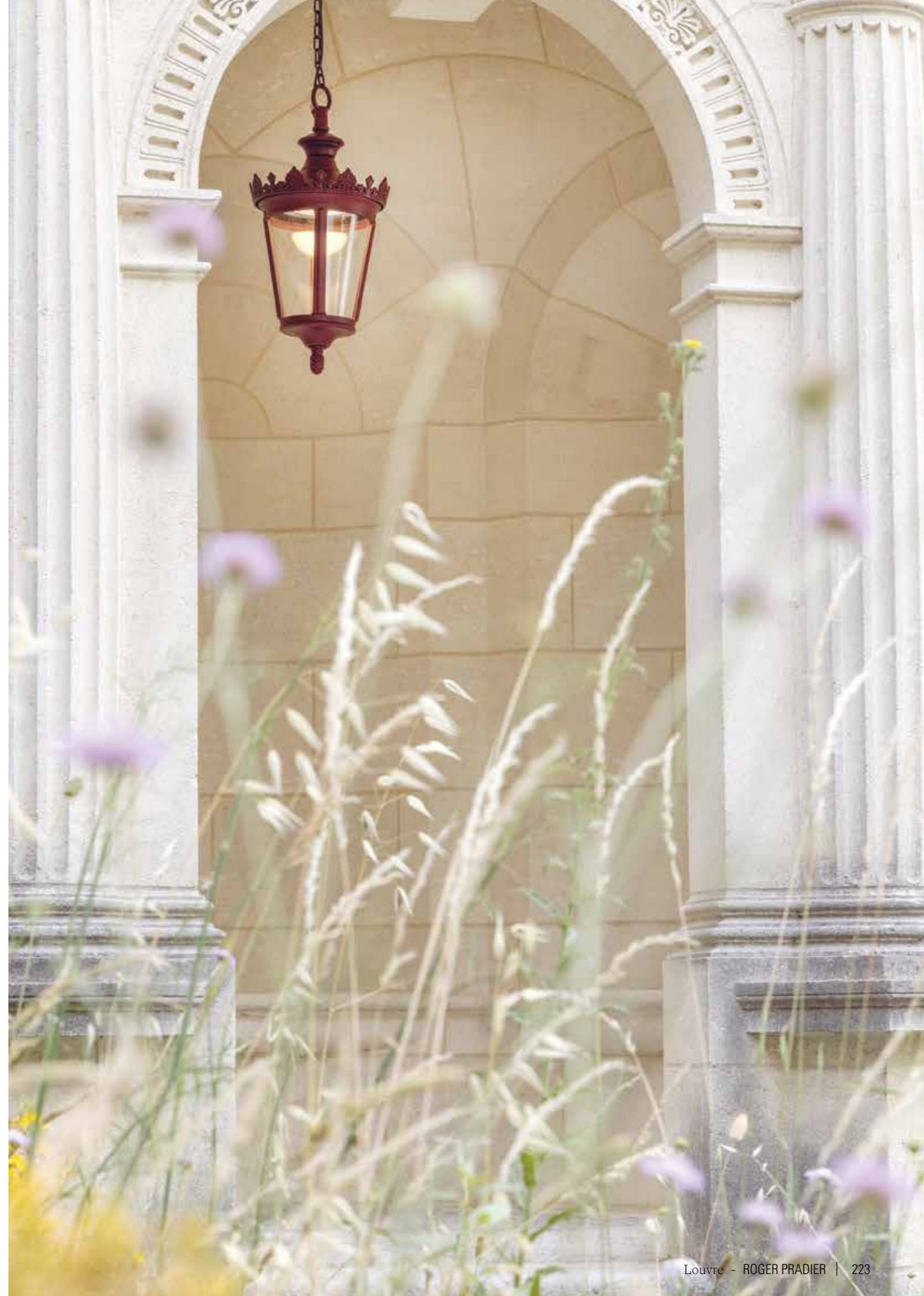



Louvre

Aluminium - Patinated lacquered copper
 Golden crown and pine cone (for all references)
 Single-colour including crown and pine cone (on request)
 Clear glass diffuser / Opal glass diffuser (on request)
 IP44 / IP65 lantern - on request (except model 4) / Class 1

SOURCES

LED 13W - 3000K warm white - IP65 LED module - triac dimmable (except model 4)
 E27 - 105W max H200 mm max (except model 4)
 Ø60 mm - H200 mm max (model 4)

PRM Eav 20 lux p.304
 Model 2

LED 13W	Pathway	Spacing
H 2,00m	2,00m	3,00m

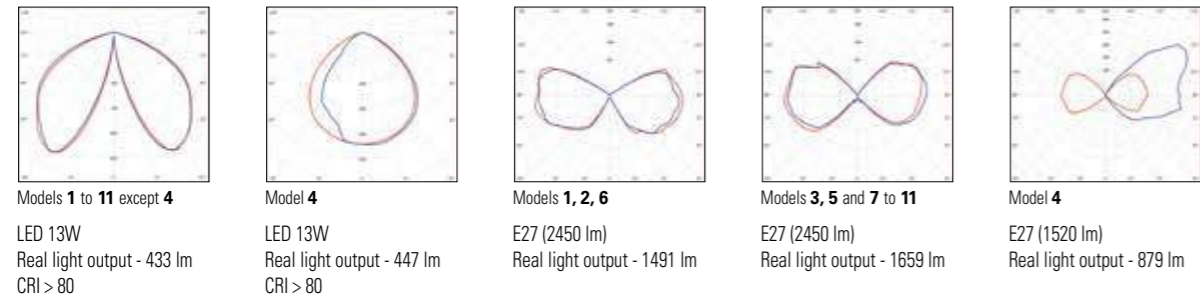

MODELS

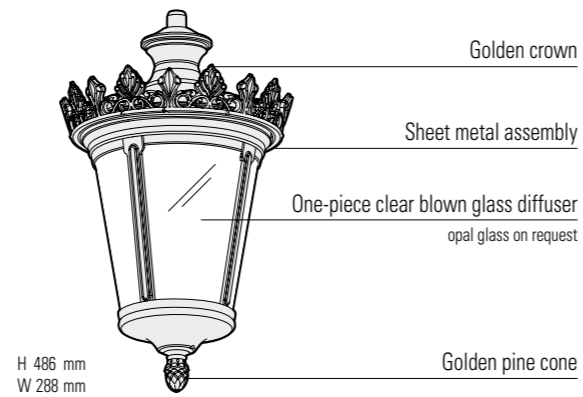
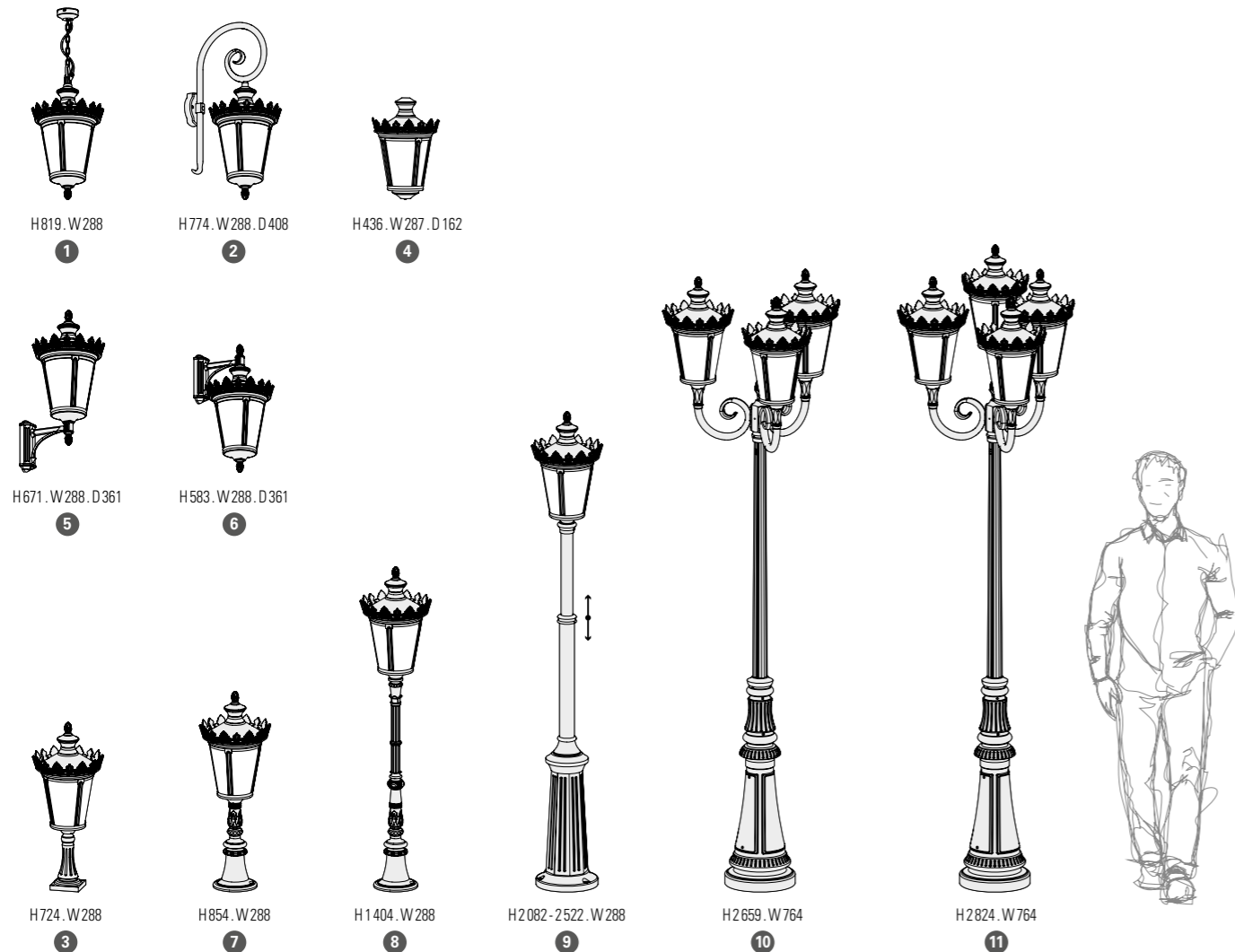

REFERENCES

Replace ... with the colour code or the material code

MODELS	E27	LED 13W 3000K warm white	CORNER PLATES	SPARE DIFFUSERS
1	133 001 ...	133 002 ...		165 038 609
2	133 003 ...	133 004 ...	147 001 ...	165 038 609
3	133 005 ...	133 006 ...		E27 165 038 609 LED 165 039 609
4	133 007 ...	133 008 ...		165 037 609
5	133 009 ...	133 010 ...	147 004 ...	E27 165 038 609 LED 165 039 609
6	133 011 ...	133 012 ...	147 004 ...	165 038 609
7	133 013 ...	133 014 ...		E27 165 038 609 LED 165 039 609
8	133 015 ...	133 016 ...		E27 165 038 609 LED 165 039 609
9	133 017 ...	133 018 ...		E27 165 038 609 LED 165 039 609
10	133 019 ...	133 020 ...		E27 165 038 609 LED 165 039 609
11	133 021 ...	133 022 ...		E27 165 038 609 LED 165 039 609



Golden
 crown and
 pine cone
 (for all references)



Single-colour
 including crown and pine cone
 (on request)

COLOURS CODES

Replace ... with the colour code

	RAL 9005 JET BLACK	000
	RAL 7044 SILK GREY	105
	RAL 3005 WINE RED	066
	RAL 6009 BRITISH GREEN	019
	RAL 6009 FIR GREEN	067
	GOLD PATINA	009

With Golden crown and pine cone
 Other colours on request

MATERIAL CODE

Replace ... with the material code

	PATINATED LACQUERED COPPER	080
--	----------------------------	-----

With Aluminium base Jet black 000 (RAL 9005)
 With Golden crown and pine cone

MOUNTING

Wiring entry points in grey
 Fixing kit included (except models 10 and 11)
 Anchor bolts on request (models 10 and 11) p.306

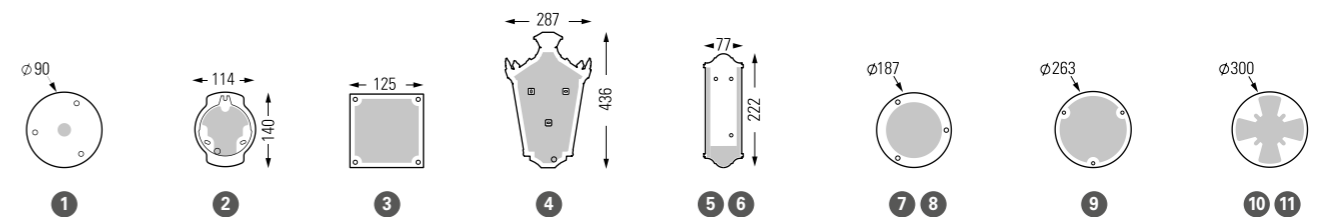

Chenonceau



Chenonceau

Aluminium
Clear glass diffuser
IP44 / Class 1

SOURCE

E27 - 75W max H 160 mm max

MODELS

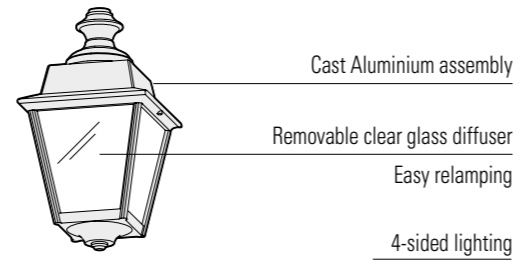
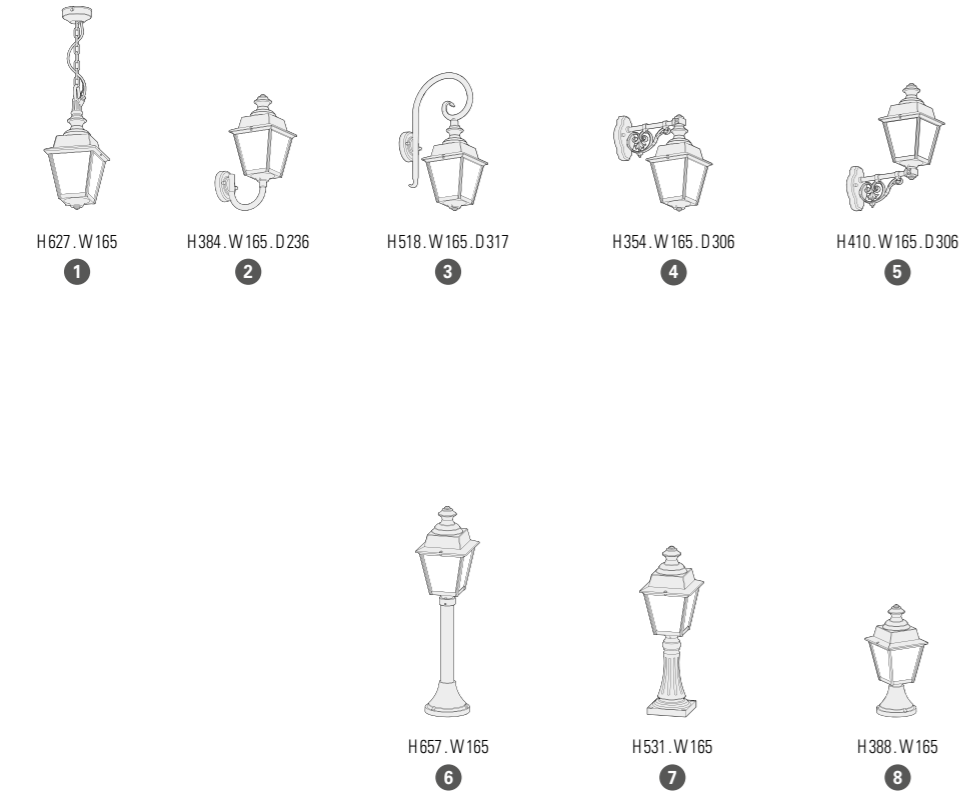

REFERENCES

Replace **•••** with the colour code

MODELS	E27	CORNER PLATE
1	117 001 •••	
2	117 002 •••	147 002 •••
3	117 003 •••	147 002 •••
4	117 004 •••	147 002 •••
5	117 005 •••	147 002 •••
6	117 006 •••	
7	117 007 •••	
8	117 008 •••	
SPARE DIFFUSER		
165 022 609		

MOUNTING

Wiring entry points in grey
Fixing kit included

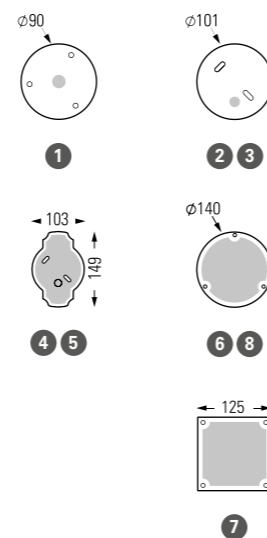

COLOURS CODES

Replace **•••** with the colour code

	RAL 9005 JET BLACK 000		RAL 6009 BRITISH GREEN 019
	SLATE GREY 059		RAL 6009 FIR GREEN 067
	WHITE 001		GREEN PATINA 008
	OLD RUSTIC 046		GOLD PATINA 009
	SANDSTONE 054	Other colours on request	



Place des Vosges 1 Tradition



Place des Vosges 1
Tradition



Place des Vosges 1
Évolution

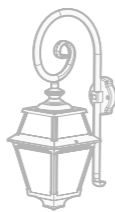

Place des Vosges 2

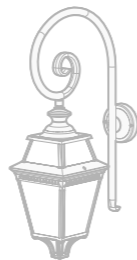

Place des Vosges 3





Place des Vosges 1 Tradition

Aluminium - Tinted lacquered brass
Clear or frosted glass diffuser
IP44 / Class 1

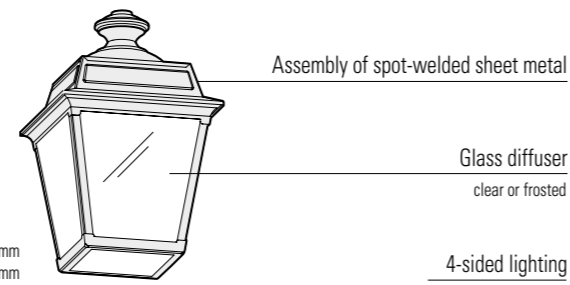

SOURCE

E27 - 105W max H 160 mm max (except model 2)
Ø 63 mm - H 160 mm max (model 2)

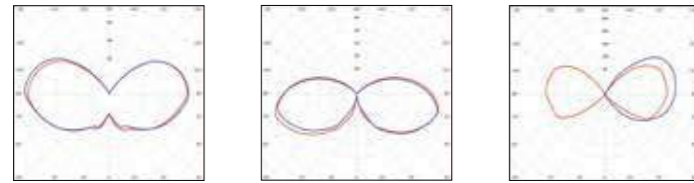

Models **1, 4, 5** E27 (2450 lm) Real light output - 1455 lm
Models **3 and 6 to 13** E27 (2450 lm) Real light output - 1098 lm
Model **2** E27 (1520 lm) Real light output - 921 lm

PRM Eav 20 lux p.304
Models **4 and 5**

E27 (2450 lm)	Pathway	Spacing
H 2,00m	2,00m	2,50m

MODELS



H664. W214 **1**
H360. W214. D125 **2**
H562. W214. D324 **3**

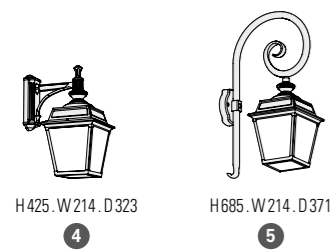

H425. W214. D323 **4**
H685. W214. D371 **5**

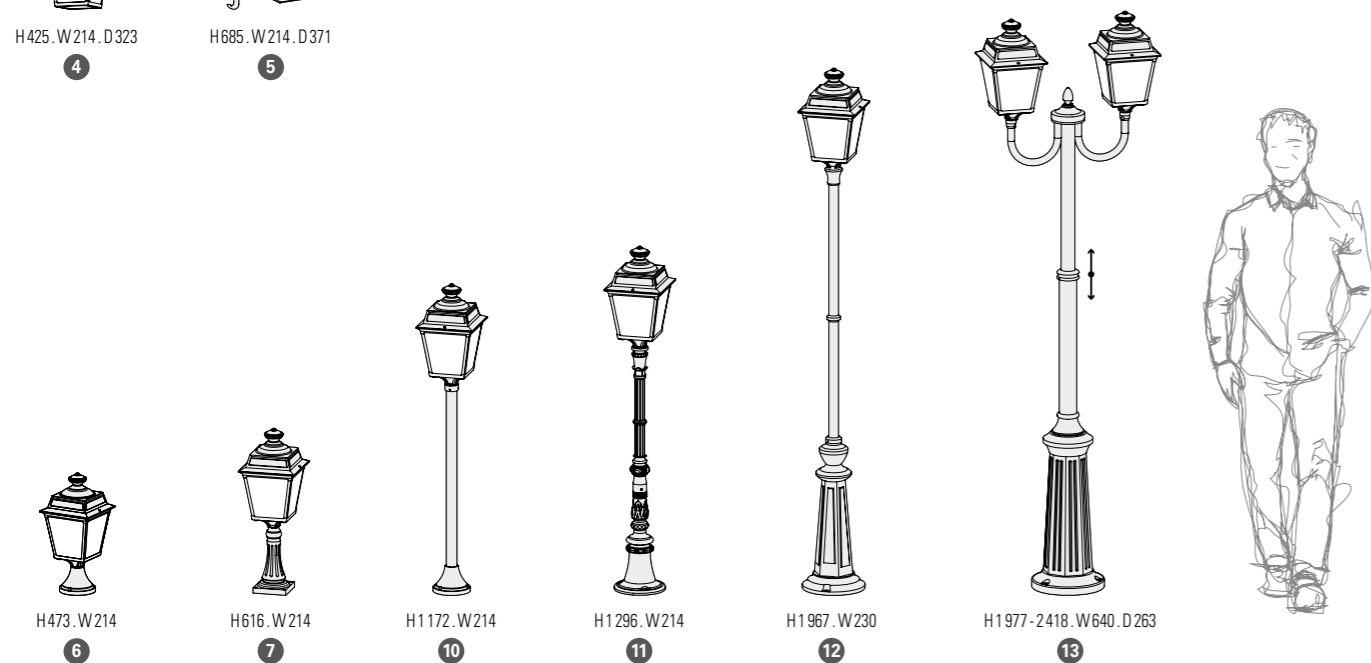

H473. W214 **6**
H616. W214 **7**
H1172. W214 **10**
H1296. W214 **11**
H1967. W230 **12**
H1977-2418. W640. D263 **13**

Place des Vosges 1 Tradition

REFERENCES

Replace **...** with the colour code or the material code

MODELS	Diffusers	E27	CORNER PLATES
1	CLEAR GLASS	151 001 ...	
	FROSTED GLASS	151 002 ...	
2	CLEAR GLASS	151 003 ...	
	FROSTED GLASS	151 004 ...	
3	CLEAR GLASS	151 005 ...	147 004 ...
	FROSTED GLASS	151 006 ...	
4	CLEAR GLASS	151 007 ...	147 004 ...
	FROSTED GLASS	151 008 ...	
5	CLEAR GLASS	151 009 ...	147 001 ...
	FROSTED GLASS	151 010 ...	
6	CLEAR GLASS	151 011 ...	
	FROSTED GLASS	151 012 ...	
7	CLEAR GLASS	151 013 ...	
	FROSTED GLASS	151 014 ...	
10	CLEAR GLASS	151 015 ...	
	FROSTED GLASS	151 016 ...	
11	CLEAR GLASS	151 017 ...	
	FROSTED GLASS	151 018 ...	
12	CLEAR GLASS	151 019 ...	
	FROSTED GLASS	151 020 ...	
13	CLEAR GLASS	151 021 ...	
	FROSTED GLASS	151 022 ...	

SPARE DIFFUSERS

CLEAR GLASS (model 2)	165 057 609
FROSTED GLASS (model 2)	165 057 610
CLEAR GLASS	165 058 609
FROSTED GLASS	165 058 610

COLOURS CODES

Replace **...** with the colour code

	RAL 9005 JET BLACK	000
	SLATE GREY	059
	WHITE	001
	OLD RUSTIC	046
	SANDSTONE	054
	RAL 6009 BRITISH GREEN	019
	RAL 6009 FIR GREEN	067
	GREEN PATINA	008
	GOLD PATINA	009

Other colours on request

MATERIAL CODE

Replace **...** with the material code

	TINTED LACQUERED BRASS	070
--	------------------------	------------

With Aluminium base Jet black 000 (RAL 9005)

MOUNTING

Wiring entry points in grey
Fixing kit included

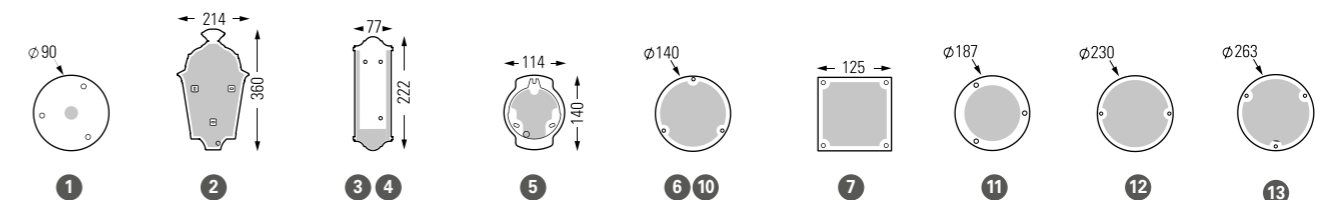

Place des Vosges 1 Évolution

Design Stéphane Joyeux



Place des Vosges 1
Tradition

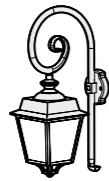

Place des Vosges 1
Évolution

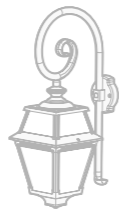

Place des Vosges 2

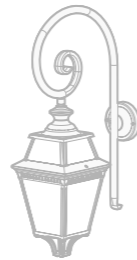

Place des Vosges 3





Place des Vosges 1 Évolution

Aluminium
Clear or opal PMMA diffuser
IP65 (lantern) / Class 1

SOURCES

E27 - 60W max (except model 2) H 160 mm max
E27 - 23W max (model 2) Ø 66 mm - H 150 mm max
GU10 PAR16 LED - 9W max (model 2) H 60 mm max

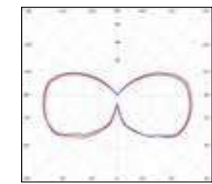

Models 1 to 13 except 2
E27 (2450 lm)
Real light output - 1348 lm

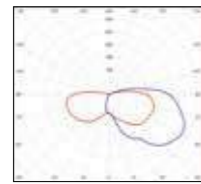

Model 2
E27 (1520 lm)
Real light output - 874 lm

PRM Eav 20 lux p.304
Models 4 and 5

E27 (2450 lm)	Pathway	Spacing
H 2,00m	2,00m	2,50m

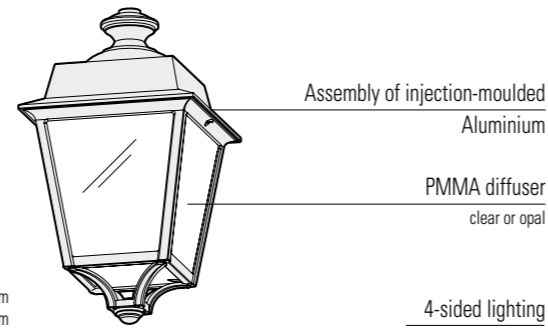

MODELS



H 728 . W 220
1



H 340 . W 216 . D 132
2



H 574 . W 220 . D 327
3

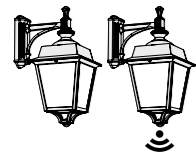

H 488 . W 220 . D 327
4



H 680 . W 220 . D 374
5



H 484 . W 220
6



H 627 . W 220
7

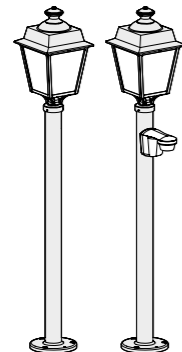

H 1 349 . W 220
9

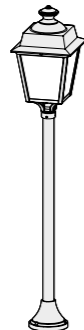

H 1 183 . W 220
10



H 1 307 . W 220
11

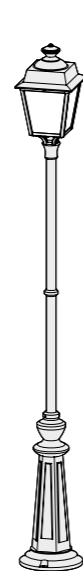

H 1 978 . W 220
12

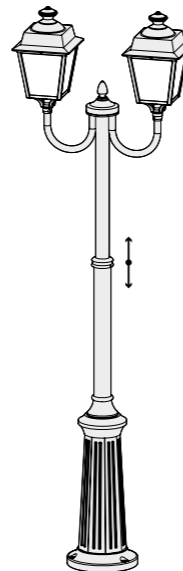

H 1 989 - 2 430 . W 647 . D 263
13



REFERENCES

Replace ●●● with the colour code

MODELS	DIFFUSERS	E27	GU10 PAR16 LED	E27 + SENSOR	CORNER PLATES
1	PMMA CLAIR	150 001 ●●●			
	OPAL PMMA	150 002 ●●●			
2	PMMA CLAIR	150 003 ●●●	150 005 ●●●	150 004 ●●●	
	OPAL PMMA	150 006 ●●●	150 008 ●●●	150 007 ●●●	
3	PMMA CLAIR	150 009 ●●●			147 004 ●●●
	OPAL PMMA	150 010 ●●●			
4	PMMA CLAIR	150 011 ●●●		150 012 ●●●	147 004 ●●●
	OPAL PMMA	150 013 ●●●		150 014 ●●●	
5	PMMA CLAIR	150 015 ●●●		150 016 ●●●	147 001 ●●●
	OPAL PMMA	150 017 ●●●		150 018 ●●●	
6	PMMA CLAIR	150 019 ●●●			
	OPAL PMMA	150 020 ●●●			
7	PMMA CLAIR	150 021 ●●●			
	OPAL PMMA	150 022 ●●●			
9	PMMA CLAIR	150 023 ●●●		150 024 ●●●	
	OPAL PMMA	150 025 ●●●		150 026 ●●●	
10	PMMA CLAIR	150 027 ●●●			
	OPAL PMMA	150 028 ●●●			
11	PMMA CLAIR	150 029 ●●●			
	OPAL PMMA	150 030 ●●●			
12	PMMA CLAIR	150 031 ●●●			
	OPAL PMMA	150 032 ●●●			
13	PMMA CLAIR	150 033 ●●●			
	OPAL PMMA	150 034 ●●●			

SPARE DIFFUSERS

CLEAR PMMA	165 056 605
OPAL PMMA	165 056 606
CLEAR PMMA (model 2)	165 055 605
OPAL PMMA (model 2)	165 055 606
CLEAR PMMA (model 2)	☺ 165 074 605
OPAL PMMA (model 2)	☺ 165 074 606

COLOURS CODES

Replace ●●● with the colour code ↴

	RAL 9005 JET BLACK 000		RAL 6009 BRITISH GREEN 019
	SLATE GREY 059		RAL 6009 FIR GREEN 067
	WHITE 001		GREEN PATINA 008
	OLD RUSTIC 046		GOLD PATINA 009
	SANDSTONE 054	Other colours on request	

MOUNTING

Wiring entry points in grey
Fixing kit included

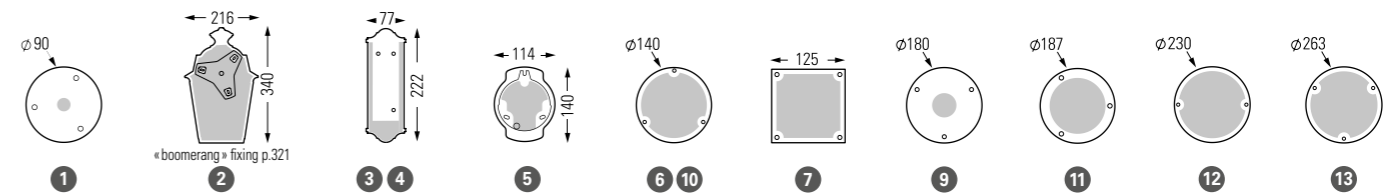

Place des Vosges 2



Place des Vosges 1
Tradition



Place des Vosges 1
Évolution



Place des Vosges 2

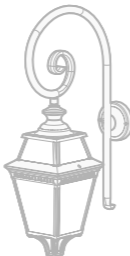

Place des Vosges 3





Place des Vosges 2

Aluminium - Tinted lacquered brass
Clear glass diffuser
IP44 / Class 1

SOURCE

E27 - 105W max H200 mm max (except model 3)
Ø66 mm - H200 mm max (model 3)

MODELS

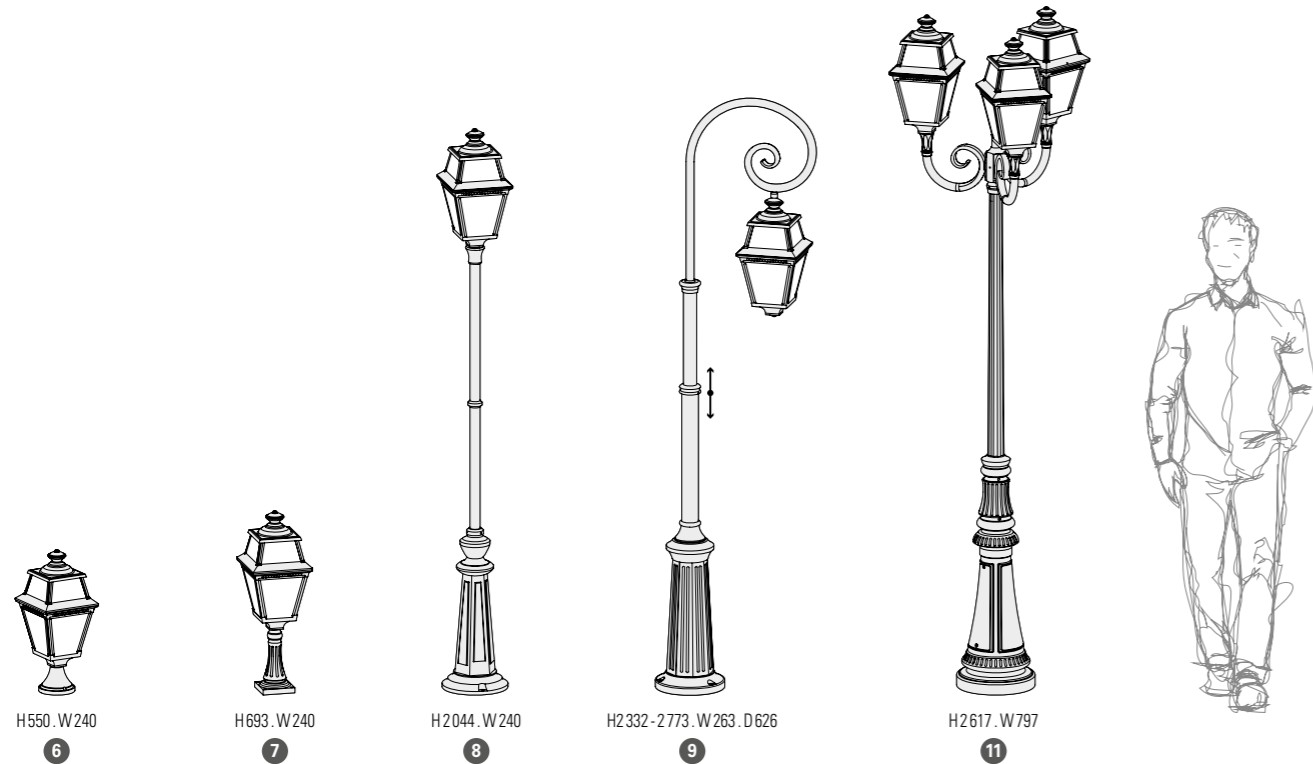
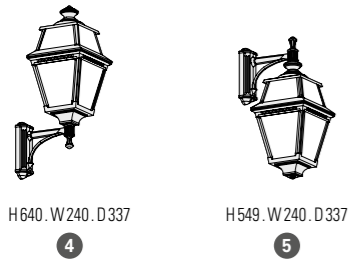
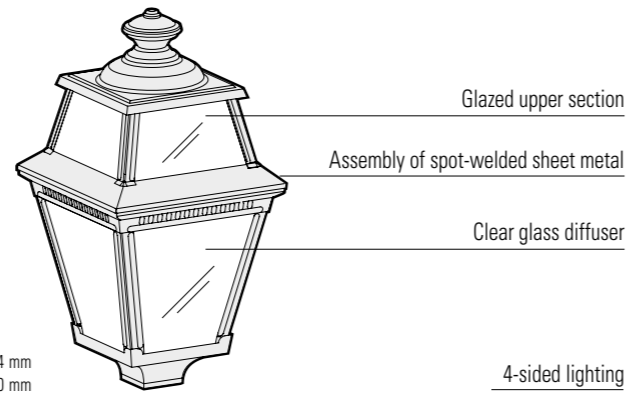

Place des Vosges 2

REFERENCES

Replace ... with the colour code or the material code

MODELS	E27	CORNER PLATES
1	148 001 ...	
2	148 002 ...	147 001 ...
3	148 003 ...	
4	148 004 ...	147 004 ...
5	148 005 ...	147 004 ...
6	148 006 ...	
7	148 007 ...	
8	148 008 ...	
9	148 009 ...	
11	148 010 ...	
SPARE DIFFUSERS		
165 052 609		
165 051 609 (model 3)		

COLOURS CODES

Replace ... with the colour code

	RAL 9005 JET BLACK	000
	WHITE	001
	OLD RUSTIC	046
	GREEN PATINA	008
	GOLD PATINA	009

Other colours on request

MATERIAL CODE

Replace ... with the material code

	TINTED LACQUERED BRASS	070
--	------------------------	-----

With Aluminium base Jet black 000 (RAL 9005)

MOUNTING

Wiring entry points in grey
Fixing kit included (except model 11)
Anchor bolts on request (model 11) p.306

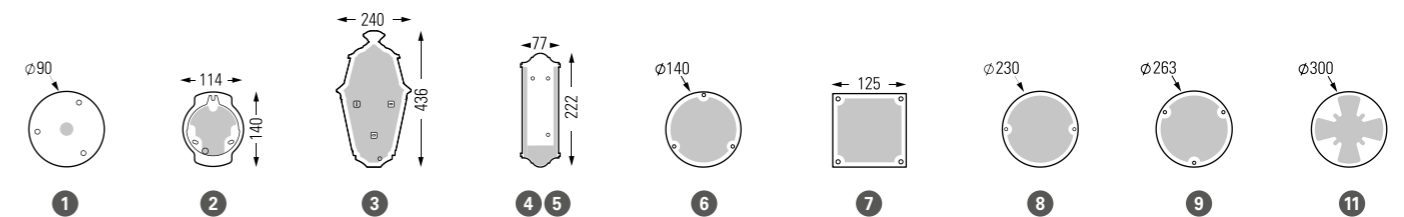

Place des Vosges 3



Place des Vosges 1
Tradition



Place des Vosges 1
Évolution

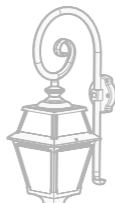

Place des Vosges 2

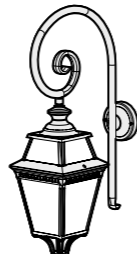

Place des Vosges 3





Place des Vosges 3

Aluminium - Tinted lacquered brass
Clear glass diffuser
IP44 / Class 1

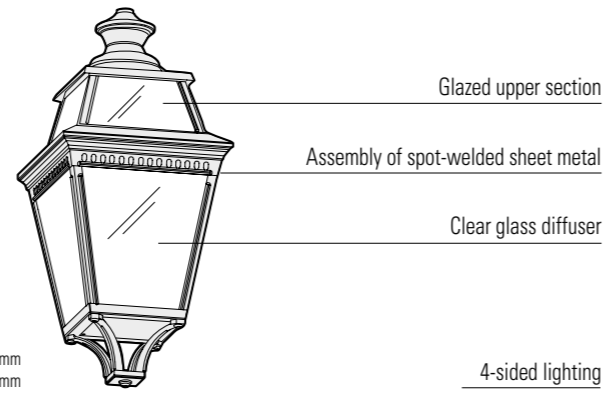

SOURCE

E27 - 105W max H220 mm max (except model 2)
Ø66 mm - H200 mm max (model 2)

MODELS

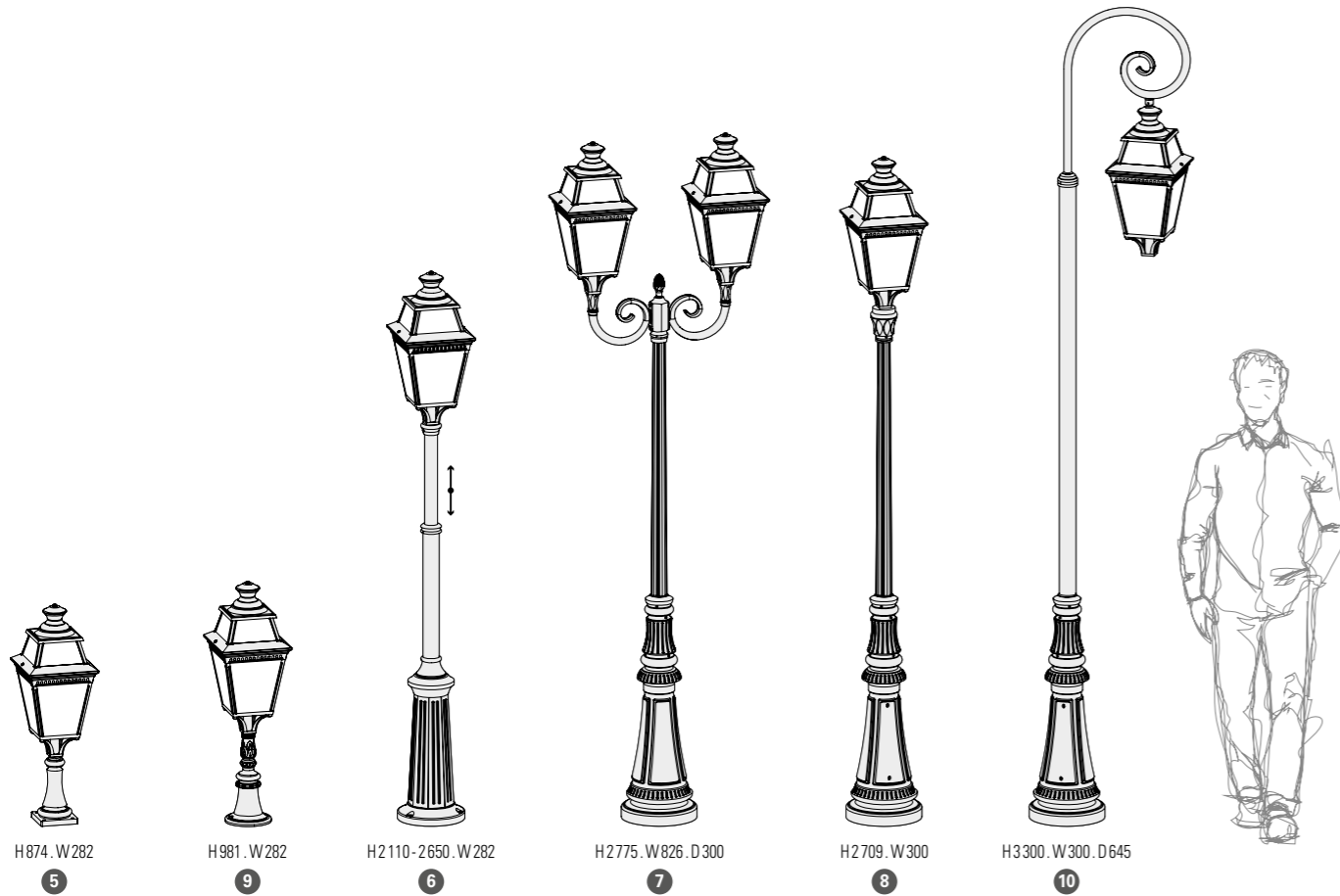

Place des Vosges 3

REFERENCES

Replace ... with the colour code or the material code

MODELS	E27	CORNER PLATES
1	149 001 ...	
2	149 002 ...	
3	149 003 ...	147 003 ...
4	149 004 ...	147 001 ...
5	149 005 ...	
6	149 006 ...	
7	149 007 ...	
8	149 008 ...	
9	149 009 ...	
10	149 010 ...	

SPARE DIFFUSERS

165 054 609
165 053 609 (model 2)

COLOURS CODES

Replace ... with the colour code

	RAL 9005 JET BLACK	000
	WHITE	001
	OLD RUSTIC	046
	GREEN PATINA	008
	GOLD PATINA	009

Other colours on request

MATERIAL CODE

Replace ... with the material code

	TINTED LACQUERED BRASS	070
--	------------------------	-----

With Aluminium base Jet black 000 (RAL 9005)

MOUNTING

Wiring entry points in grey
Fixing kit included (except models 7, 8, 10)
Anchor bolts on request (models 7, 8, 10) p.306

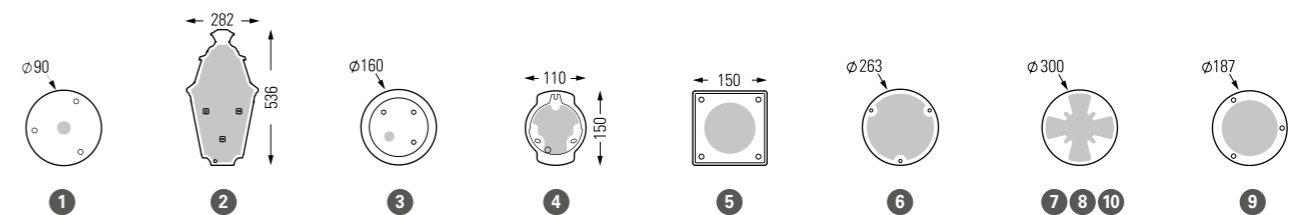

Avenue 2

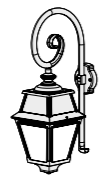

Avenue 2

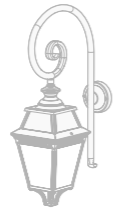

Avenue 3

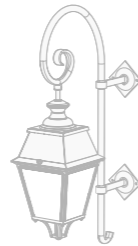

Avenue 4





Avenue 2

Aluminium - Tinted lacquered brass
Clear glass or opal PMMA diffuser
IP44 / Class 1

SOURCES

LED 13W - 3000K warm white - IP65 LED module - triac dimmable
E27 - 105W max H200 mm max (except model 3)
Ø66 mm - H200 mm max (model 3)

PRM Eav 20 lux p.304
Models 2 and 4

LED 13W	Pathway	Spacing
H 2,00m	2,00m	3,50m

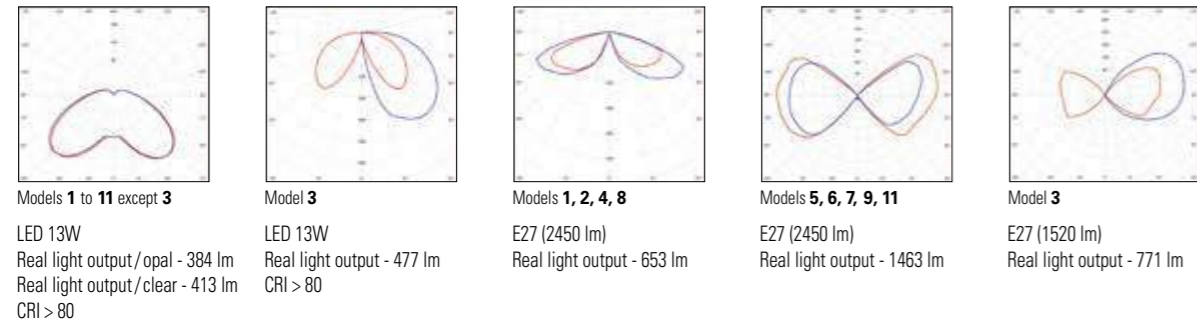

MODELS

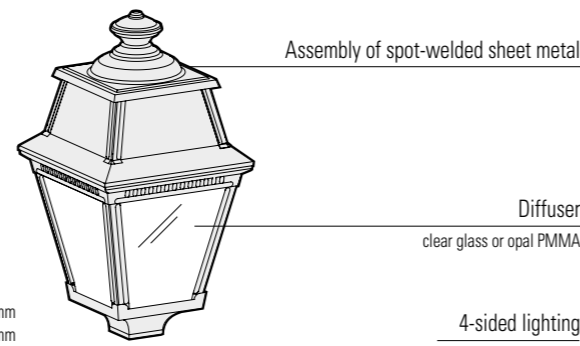
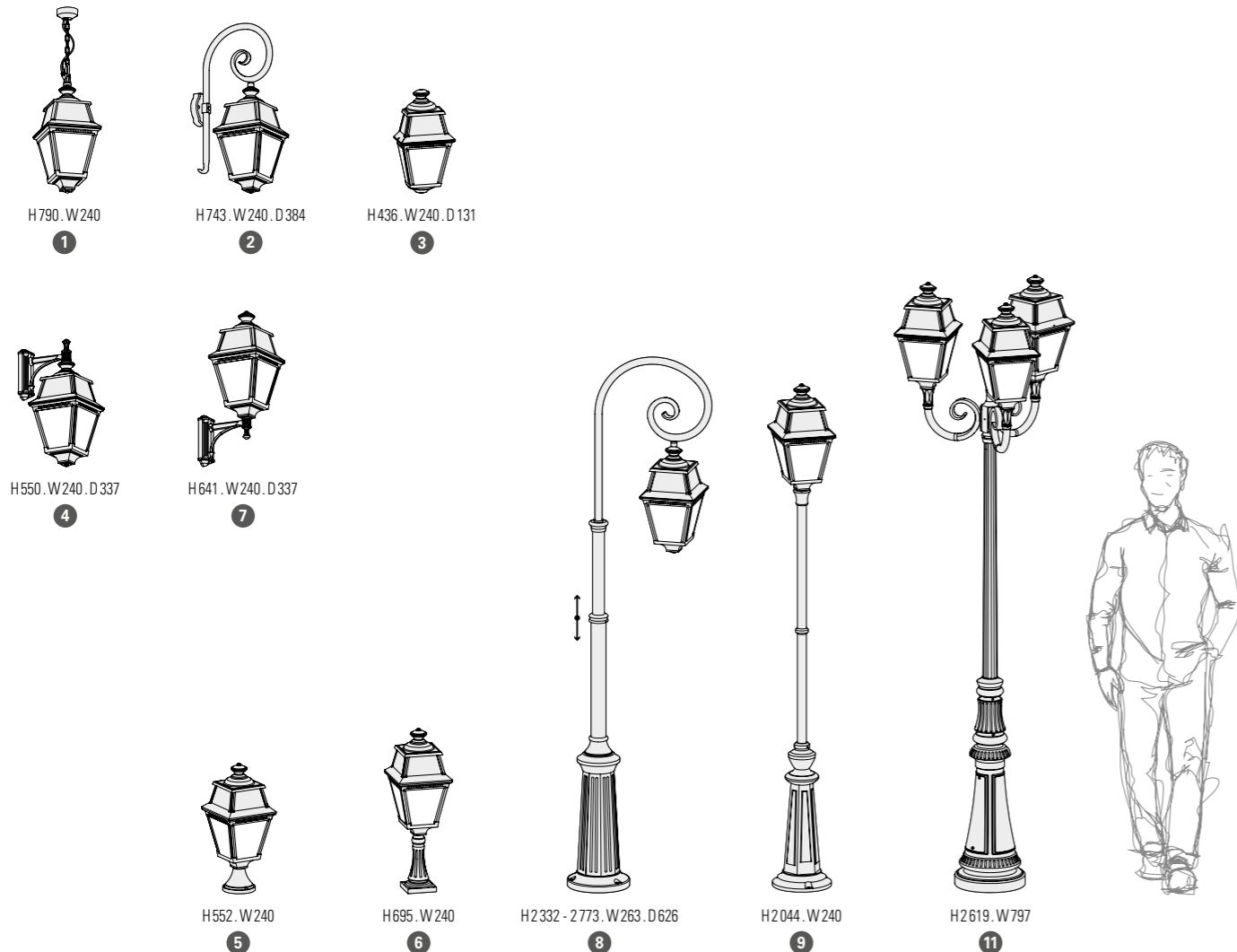

Avenue 2

REFERENCES

Replace ... with the colour code or the material code

MODELS	DIFFUSERS	E27	LED 13W 3000K warm white	CORNER PLATES
1	CLEAR GLASS	102 001 ...	102 002 ...	
	OPAL PMMA		102 003 ...	
2	CLEAR GLASS	102 004 ...	102 005 ...	147 001 ...
	OPAL PMMA		102 006 ...	
3	CLEAR GLASS	102 007 ...	102 008 ...	
4	CLEAR GLASS	102 010 ...	102 011 ...	147 004 ...
	OPAL PMMA		102 012 ...	
5	CLEAR GLASS	102 013 ...	102 014 ...	
	OPAL PMMA		102 015 ...	
6	CLEAR GLASS	102 016 ...	102 017 ...	
	OPAL PMMA		102 018 ...	
7	CLEAR GLASS	102 019 ...	102 020 ...	147 004 ...
	OPAL PMMA		102 021 ...	
8	CLEAR GLASS	102 022 ...	102 023 ...	
	OPAL PMMA		102 024 ...	
9	CLEAR GLASS	102 025 ...	102 026 ...	
	OPAL PMMA		102 027 ...	
11	CLEAR GLASS	102 028 ...	102 029 ...	
	OPAL PMMA		102 030 ...	
SPARE DIFFUSERS				
	CLEAR GLASS	165 003 609		
	CLEAR GLASS	165 002 609 (model 3)		
	OPAL PMMA	165 003 606 (except model 3)		

COLOURS CODES

Replace ... with the colour code

	RAL 9005 JET BLACK	000
	RAL 6009 BRITISH GREEN	019
	RAL 6009 FIR GREEN	067
	GREEN PATINA	008
	GOLD PATINA	009

Other colours on request

MATERIAL CODE

Replace ... with the material code

	TINTED LACQUERED BRASS	070
--	------------------------	-----

With Aluminium base Jet black 000 (RAL 9005)

MOUNTING

Wiring entry points in grey
Fixing kit included (except model 11)
Anchor bolts on request (model 11) p.306

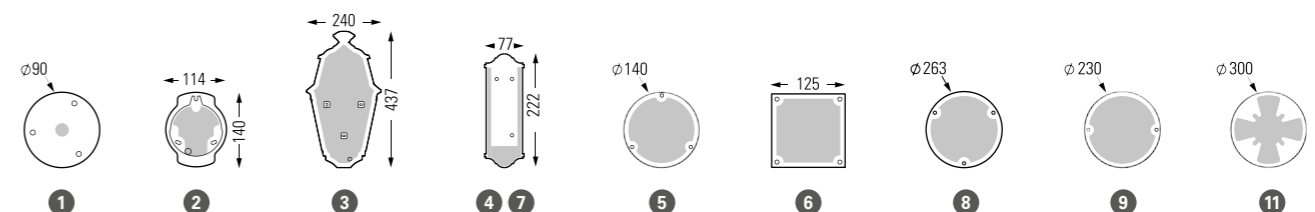

Avenue 3

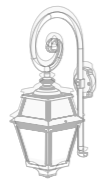

Avenue 2

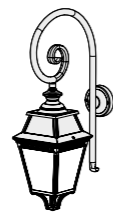

Avenue 3

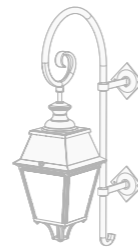

Avenue 4





Avenue 3

Aluminium
Clear glass or opal PMMA diffuser
IP44 / Class 1

SOURCES

LED 35W - 3000K warm white - IP65 LED module
LED 35W - 4000K neutral white - IP65 LED module
E27 - 105W max H 220 mm max (except model 2)
Ø 66 mm - H 200 mm max (model 2)

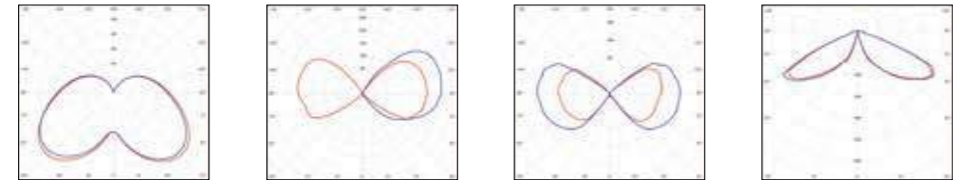
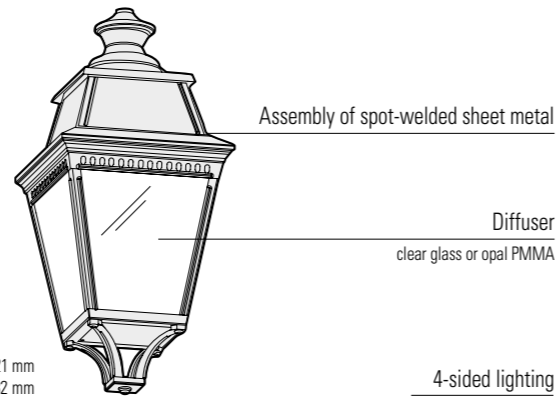

Models 1 to 12 except 2: LED 35W, Real light output/opal - 1727 lm, Real light output/clear - 1444 lm, CRI > 80
Model 2: E27 (2450 lm), Real light output - 1304 lm
Models 4 to 8 and 11, 12: E27 (2450 lm), Real light output - 1603 lm
Models 1, 3, 9: E27 (2450 lm), Real light output - 506 lm

PRM Eav 20 lux p.304
Model 3

LED 35W	Pathway	Spacing
H 2,50m	2,50m	7,00m

MODELS

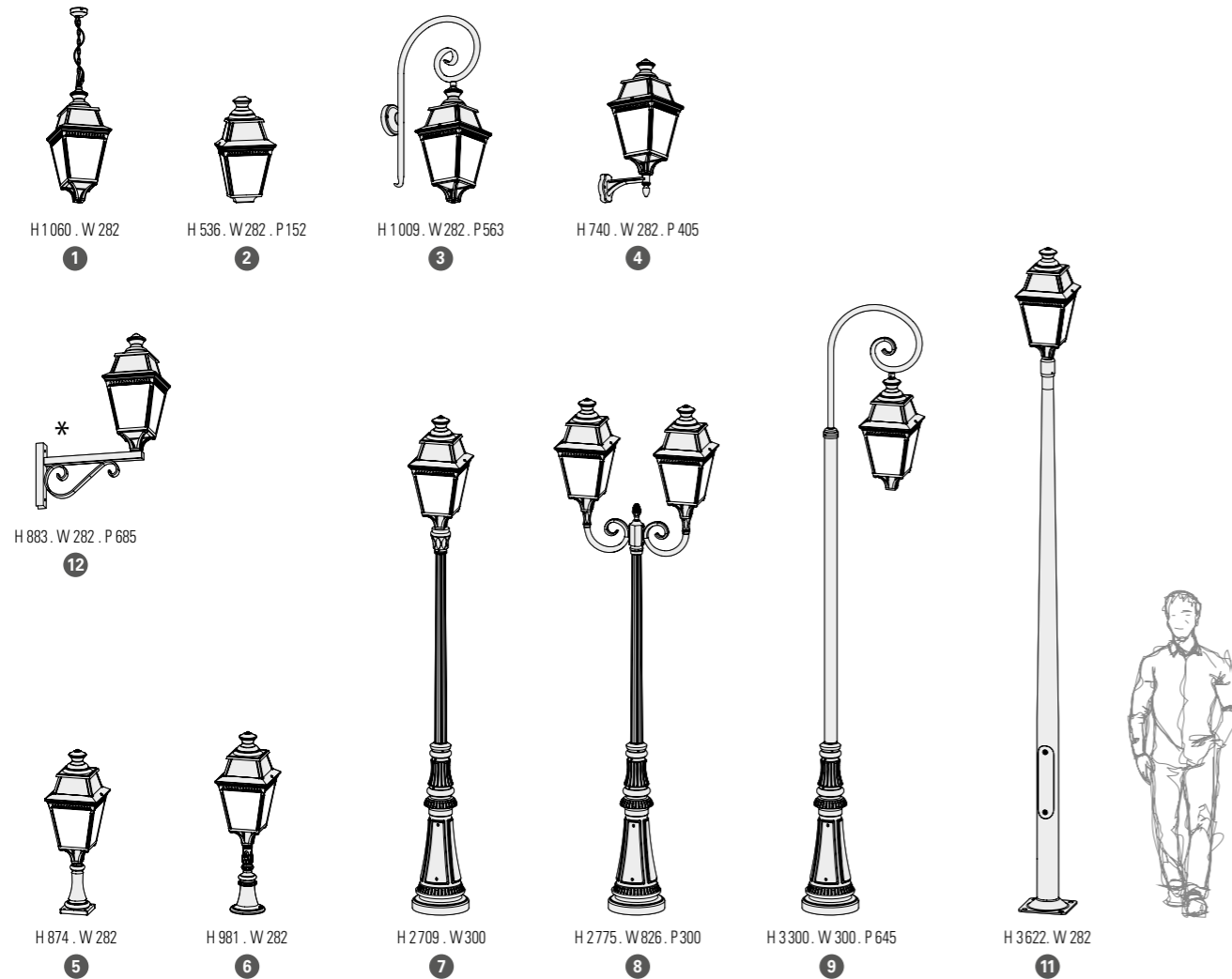

* 12 : bichromated steel support

Avenue 3

REFERENCES

Replace ... with the colour code

MODELS	DIFFUSERS	E27	LED 35W - 3000K warm white	LED 35W - 4000K neutral white	CORNER PLATES
1	CLEAR GLASS	103 001 ...	103 002 ...	103 003 ...	
	OPAL PMMA		103 004 ...	103 005 ...	
2	CLEAR GLASS	103 006 ...			
3	CLEAR GLASS	103 007 ...	103 008 ...	103 009 ...	147 003 ...
	OPAL PMMA		103 010 ...	103 011 ...	
4	CLEAR GLASS	103 012 ...	103 013 ...	103 014 ...	147 001 ...
	OPAL PMMA		103 015 ...	103 016 ...	
5	CLEAR GLASS	103 017 ...	103 018 ...	103 019 ...	
	OPAL PMMA		103 020 ...	103 021 ...	
6	CLEAR GLASS	103 022 ...	103 023 ...	103 024 ...	
	OPAL PMMA		103 025 ...	103 026 ...	
7	CLEAR GLASS	103 027 ...	103 028 ...	103 029 ...	
	OPAL PMMA		103 030 ...	103 031 ...	
8	CLEAR GLASS	103 032 ...	103 043 ...	103 044 ...	
	OPAL PMMA		103 045 ...	103 046 ...	
9	CLEAR GLASS	103 037 ...	103 038 ...	103 039 ...	
	OPAL PMMA		103 040 ...	103 041 ...	
11	CLEAR GLASS	103 057 ...	103 058 ...	103 059 ...	
	OPAL PMMA		103 060 ...	103 061 ...	
12	CLEAR GLASS	103 052 ...	103 053 ...	103 054 ...	
	OPAL PMMA		103 055 ...	103 056 ...	

SPARE DIFFUSERS

CLEAR GLASS	165 005 609
CLEAR GLASS (model 2)	165 004 609
OPAL PMMA (except model 2)	165 005 606

COLOURS CODES

Replace ... with the colour code

	RAL 9005 JET BLACK	000
	RAL 6009 FIR GREEN	067
	GREEN PATINA	008
	GOLD PATINA	009

Models 1 to 9 and model 12

	RAL 9005 JET BLACK	000
	RAL 6009 BRITISH GREEN	019
	RAL 6009 FIR GREEN	067

Model 11

Other colours on request

MOUNTING

Wiring entry points in grey
Fixing kit included (except model 7 to 12)
Anchor bolts on request (models 7 to 11) p.306

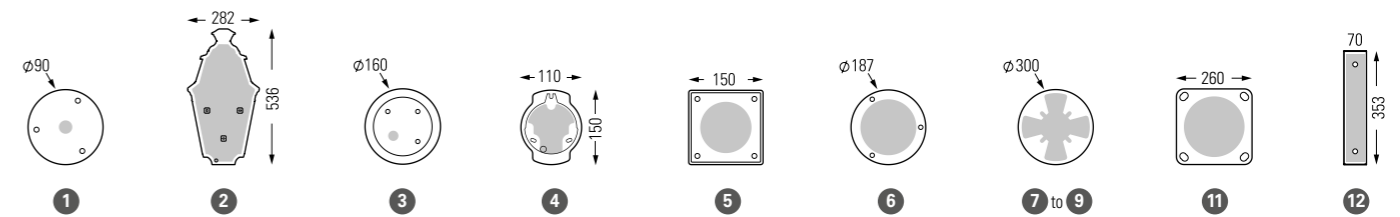

Avenue 4

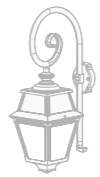

Avenue 2

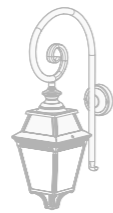

Avenue 3

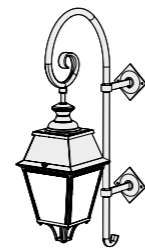

Avenue 4



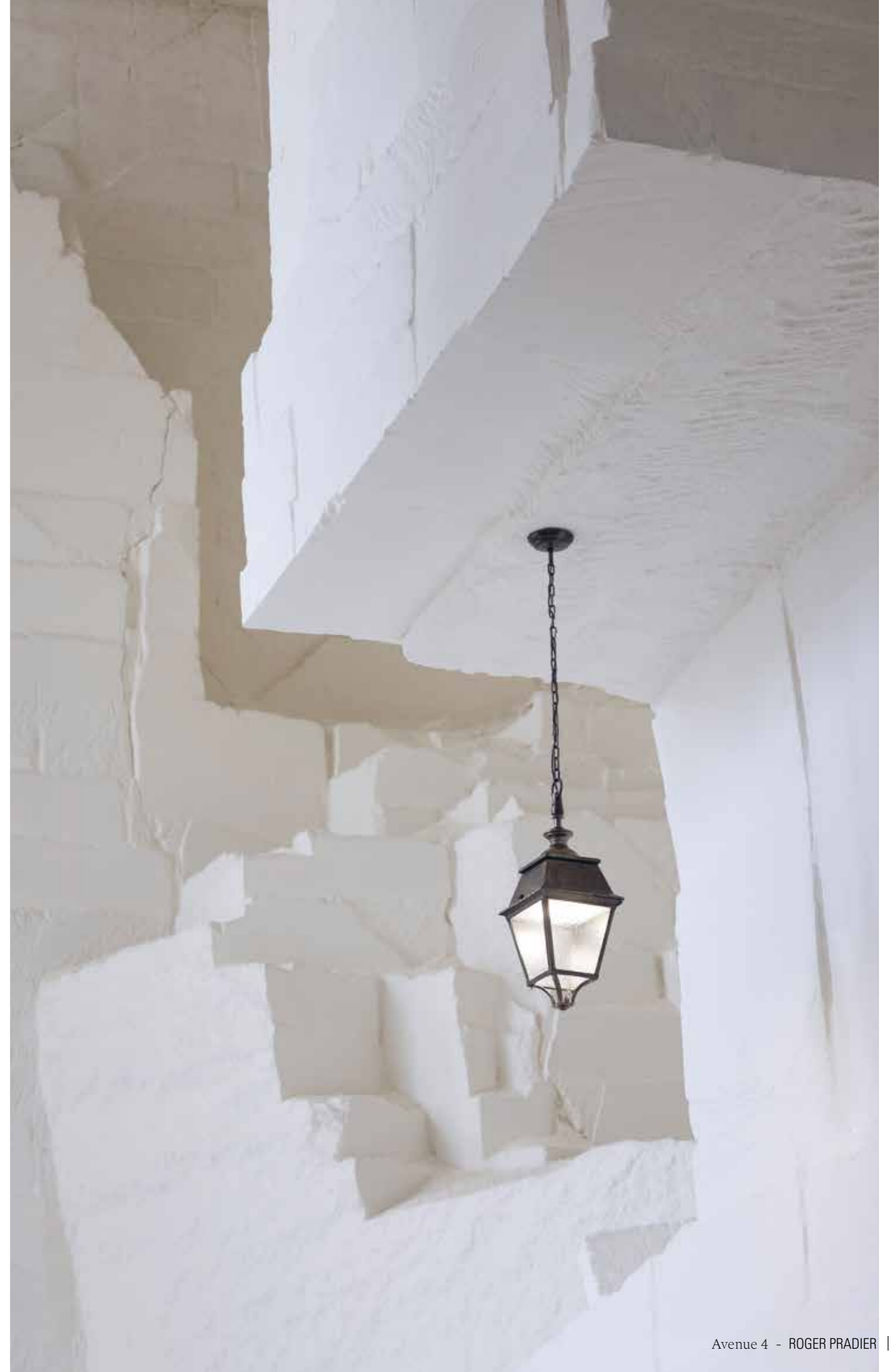

Avenue 4

Aluminium
Opal or clear structured PMMA diffuser for IP65
Opal or clear PMMA diffuser for IP44
IP65 - LED (lantern except model 2 IP44) / IP44 - E27 (IP65 version on request)
Class 1

SOURCES

LED 35W - 3000K warm white - IP65 LED module
LED 35W - 4000K neutral white - IP65 LED module
LED 70W - 3000K warm white - IP65 LED module
LED 70W - 4000K neutral white - IP65 LED module
Asymmetric and dimmable LED module on request
E27 - 105W max H 280 mm max (except model 2)
Ø 80 mm - H 160 mm max (model 2)

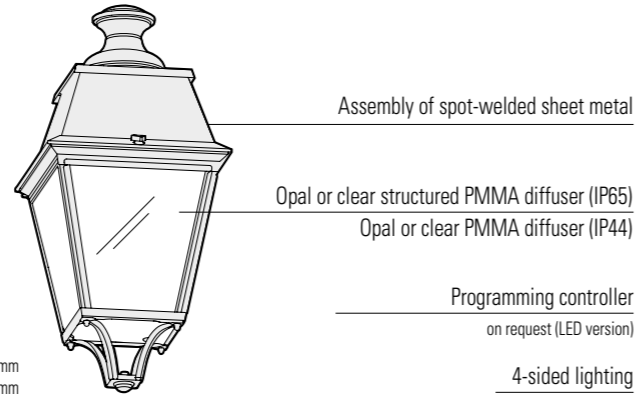

H 749 mm
W 364 mm

PRM Eav 20 lux p.304
Model 5

LED 35W	Pathway	Spacing
H 3,50 m	3,50 m	10,00 m

Model 8

LED 70W	Pathway	Spacing
H 4,50 m	4,50 m	15,00 m

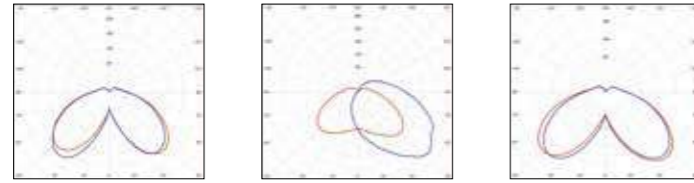

Models 1 to 9 except 2

Model 2

Models 1 to 9 except 2

LED 35W
Real light output/opal - 2693 lm
Real light output/clear - 2676 lm
CRI > 80

LED 35W
Real light output/opal - 2596 lm
Real light output/clear - 2229 lm
CRI > 80

LED 70W
Real light output/opal - 5868 lm
Real light output/clear - 5791 lm
CRI > 80

MODELS

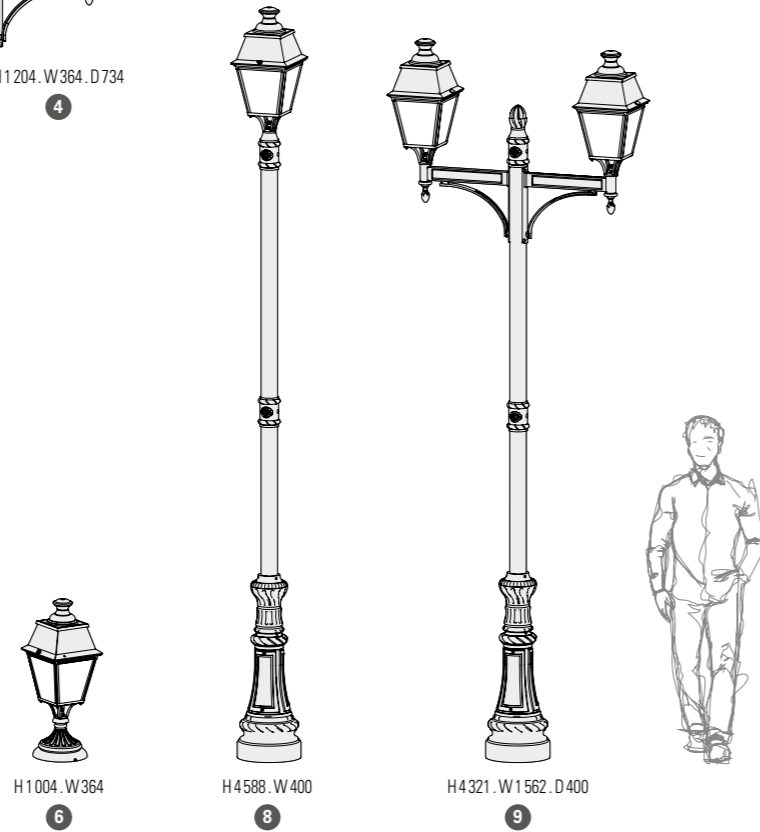
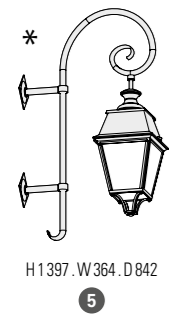
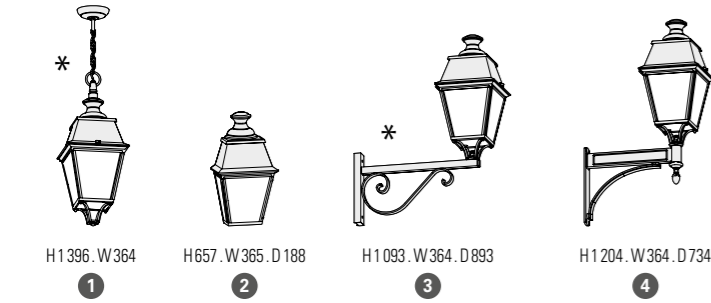

* 1 3 5 : bichromated steel support

Avenue 4

REFERENCES

Replace ●●● with the colour code

MODELS	DIFFUSERS	E27	LED 35W 3000K warm white	LED 35W 4000K neutral white	SPARE DIFFUSERS
1	CLEAR PMMA	104 001 ●●●			165 007 605
	OPAL PMMA	104 018 ●●●			165 007 606
2	CLEAR PMMA	104 035 ●●●	104 249 ●●●	104 250 ●●●	165 006 605
	OPAL PMMA	104 040 ●●●	104 251 ●●●	104 252 ●●●	165 006 606
3	CLEAR PMMA	104 045 ●●●			165 008 605
	OPAL PMMA	104 062 ●●●			165 008 606
4	CLEAR PMMA	104 079 ●●●			165 008 605
	OPAL PMMA	104 096 ●●●			165 008 606
5	CLEAR PMMA	104 113 ●●●			165 007 605
	OPAL PMMA	104 130 ●●●			165 007 606
6	CLEAR PMMA	104 215 ●●●			165 008 605
	OPAL PMMA	104 232 ●●●			165 008 606
8	CLEAR PMMA	104 147 ●●●			165 008 605
	OPAL PMMA	104 164 ●●●			165 008 606
9	CLEAR PMMA	104 181 ●●●			165 008 605
	OPAL PMMA	104 198 ●●●			165 008 606

MODELS	DIFFUSERS	LED 35W 3000K warm white	LED 35W 4000K neutral white	LED 70W 3000K warm white	LED 70W 4000K neutral white	SPARE DIFFUSERS
1	CLEAR STRUCTURED PMMA	104 010 ●●●	104 012 ●●●	104 011 ●●●	104 013 ●●●	165 009 608
	OPAL PMMA	104 027 ●●●	104 029 ●●●	104 028 ●●●	104 030 ●●●	165 009 606
3	CLEAR STRUCTURED PMMA	104 054 ●●●	104 056 ●●●	104 055 ●●●	104 057 ●●●	165 010 608
	OPAL PMMA	104 071 ●●●	104 073 ●●●	104 072 ●●●	104 074 ●●●	165 010 606
4	CLEAR STRUCTURED PMMA	104 088 ●●●	104 090 ●●●	104 089 ●●●	104 091 ●●●	165 010 608
	OPAL PMMA	104 105 ●●●	104 107 ●●●	104 106 ●●●	104 108 ●●●	165 010 606
5	CLEAR STRUCTURED PMMA	104 122 ●●●	104 124 ●●●	104 123 ●●●	104 125 ●●●	165 009 608
	OPAL PMMA	104 139 ●●●	104 141 ●●●	104 140 ●●●	104 142 ●●●	165 009 606
6	CLEAR STRUCTURED PMMA	104 224 ●●●	104 226 ●●●	104 225 ●●●	104 227 ●●●	165 010 608
	OPAL PMMA	104 241 ●●●	104 243 ●●●	104 242 ●●●	104 244 ●●●	165 010 606
8	CLEAR STRUCTURED PMMA	104 156 ●●●	104 158 ●●●	104 157 ●●●	104 159 ●●●	165 010 608
	OPAL PMMA	104 173 ●●●	104 175 ●●●	104 174 ●●●	104 176 ●●●	165 010 606
9	CLEAR STRUCTURED PMMA	104 190 ●●●	104 192 ●●●	104 191 ●●●	104 193 ●●●	165 010 608
	OPAL PMMA	104 207 ●●●	104 209 ●●●	104 208 ●●●	104 210 ●●●	165 010 606

COLOURS CODES

Replace ●●● with the colour code

	RAL 9005 JET BLACK	000
	GREEN PATINA	008
	GOLD PATINA	009

Other colours on request

MOUNTING

Wiring entry points in grey - Fixing kit included (model 2 only)

Anchor bolts on request (models 6, 8, 9) p.306

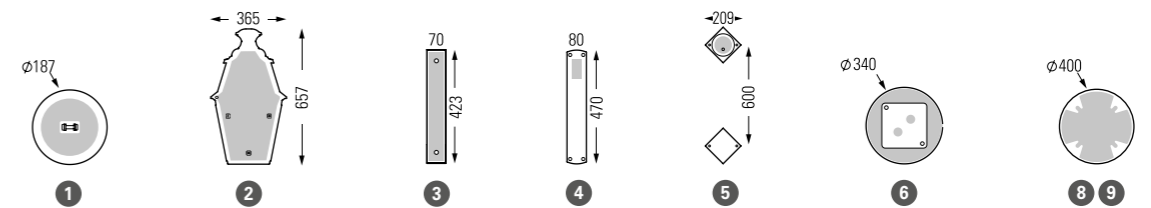

Victoria



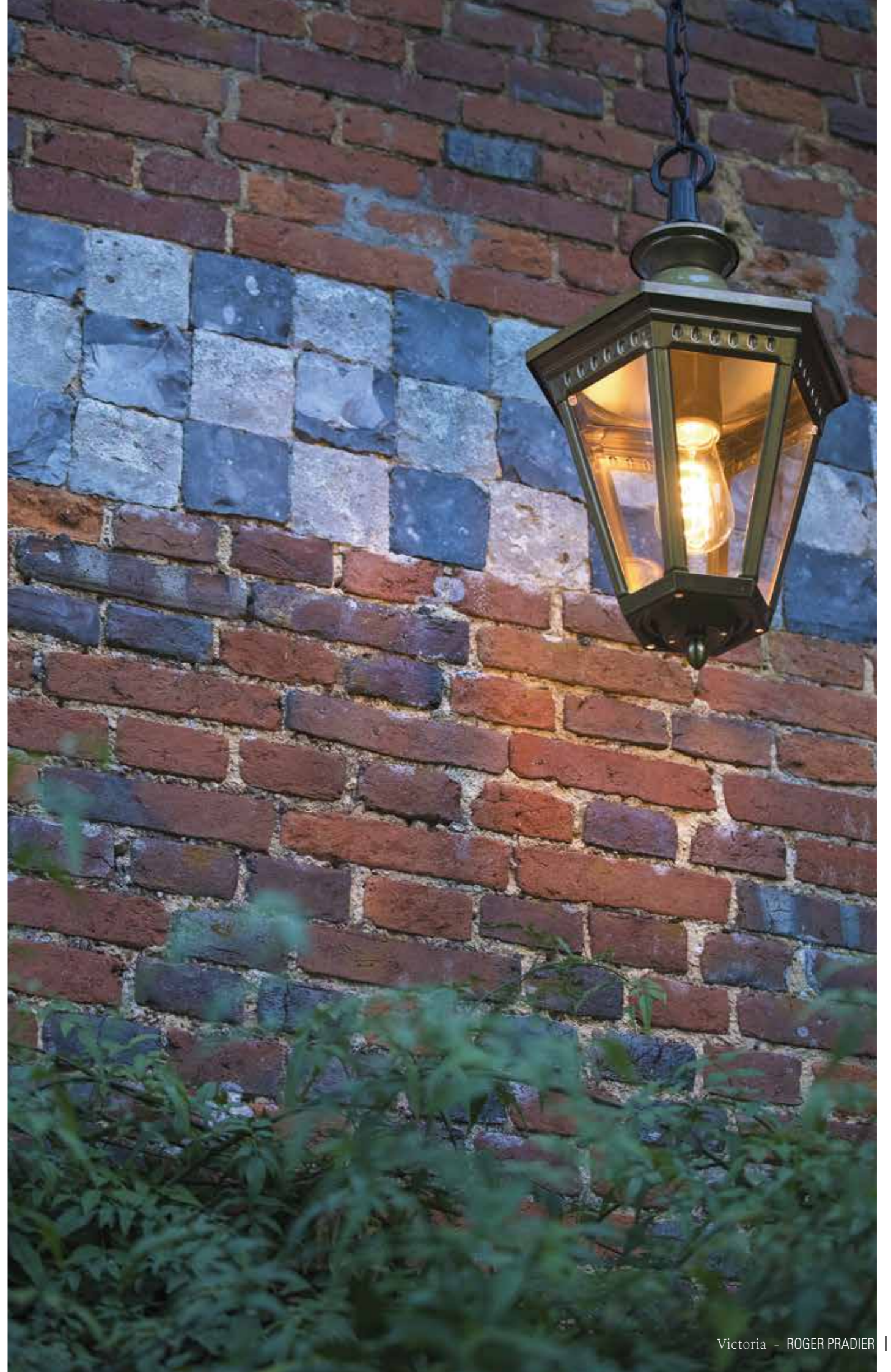

Victoria

Aluminium - Tinted lacquered brass
 Clear polycarbonate diffuser / opal polycarbonate diffuser on request
 IP44 / Class 1

SOURCES

E27 - 105W max (except model 1) H 200 mm max
 E27 - 75W max (model 1) Ø 63 mm - H 120 mm max

MODELS

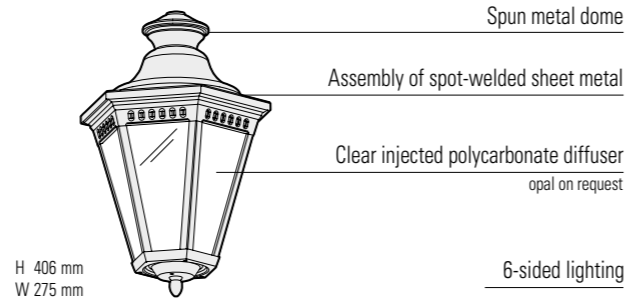
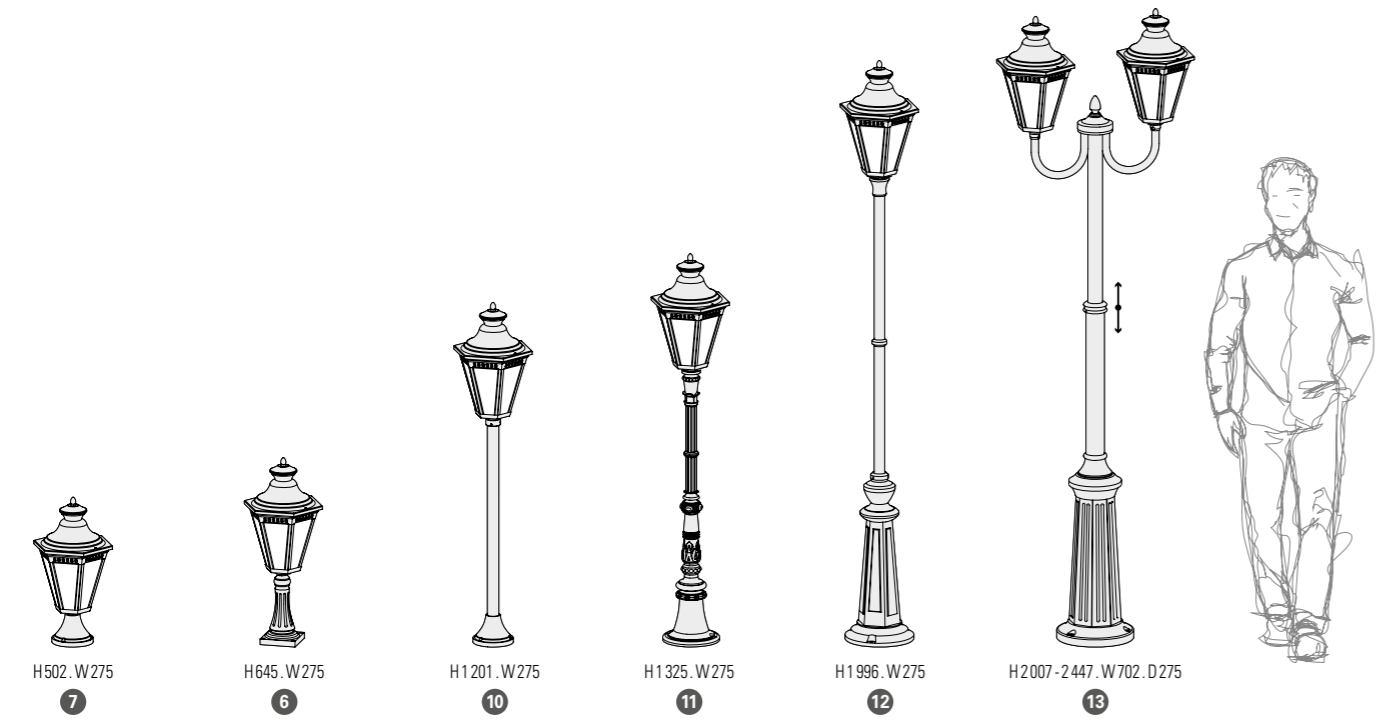
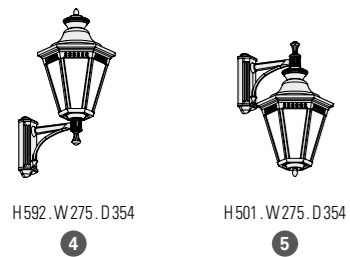

Victoria

REFERENCES

Replace ... with the colour code or the material code

MODELS	E27	CORNER PLATES
1	164 001 ...	
2	164 002 ...	
3	164 003 ...	147 001 ...
4	164 004 ...	147 004 ...
5	164 005 ...	147 004 ...
6	164 006 ...	
7	164 007 ...	
10	164 008 ...	
11	164 009 ...	
12	164 010 ...	
13	164 011 ...	
SPARE DIFFUSERS		
165 069 601 (model 1)		
165 070 601		

COLOURS CODES

Replace ... with the colour code

	RAL 9005 JET BLACK	000
	SLATE GREY	059
	WHITE	001
	OLD RUSTIC	046
	GREEN PATINA	008
	GOLD PATINA	009

Other colours on request

MATERIAL CODE

Replace ... with the material code

	TINTED LACQUERED BRASS	070
--	------------------------	-----

With Aluminium base Jet black colour 000 (RAL 9005)

MOUNTING

Wiring entry points in grey
 Fixing kit included

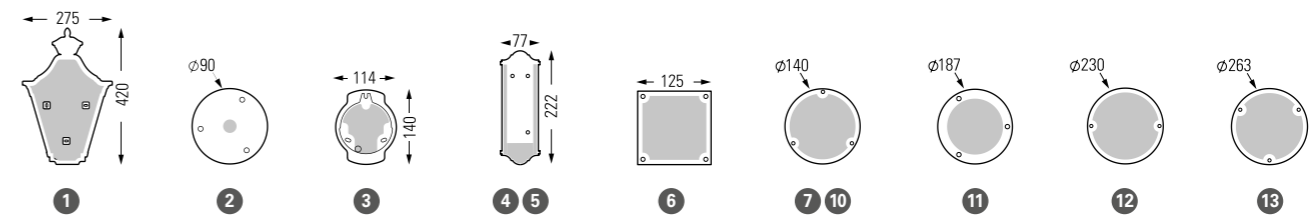

Louis XIII





Louis XIII

Aluminium - Tinted lacquered brass
Clear glass diffuser or opal PMMA diffuser on request
IP44 / Class 1

SOURCES

LED 13W - 3000K warm white - IP65 LED module - triac dimmable (except model 2)
E27 - 105W max H 220 mm max (except model 2)
Ø 66 mm - H 200 mm max (model 2)

PRM Eav 20 lux p.304
Model 3

LED 13W	Pathway	Spacing
H 2,00m	2,00m	3,00m

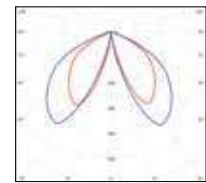

Models 1 to 9 except 2

LED 13W
Real light output - 361 lm
CRI > 80

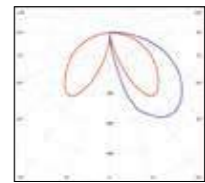

Model 2

LED 13W
Real light output - 473 lm
CRI > 80

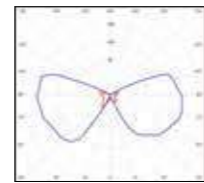

Models 1 and 3

E27 (2450 lm)
Real light output - 1220 lm

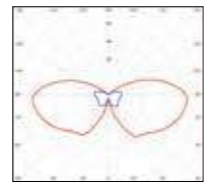

Models 4 to 9

E27 (2450 lm)
Real light output - 987 lm

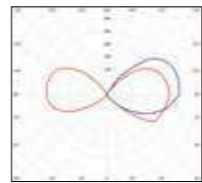

Model 2

E27 (1520 lm)
Real light output - 729 lm

H 526 mm
W 344 mm

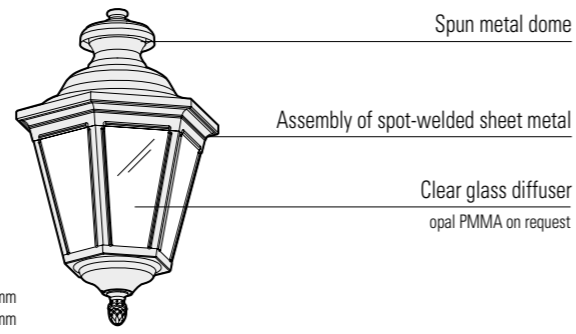

MODELS

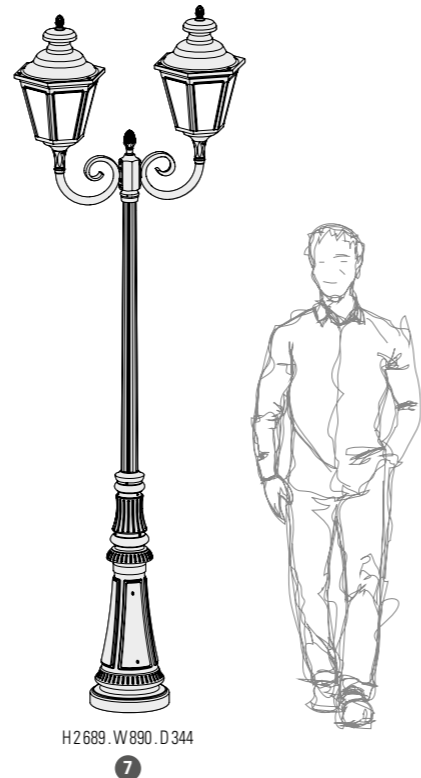
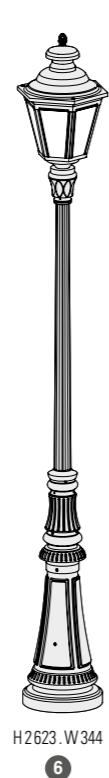
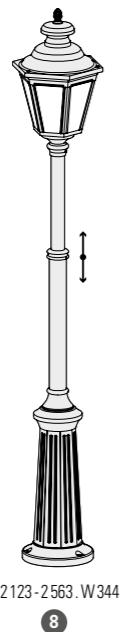
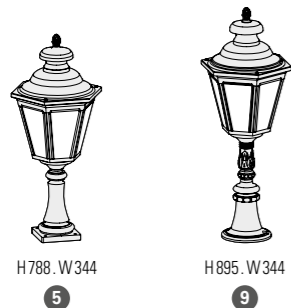

Louis XIII

REFERENCES

Replace ... with the colour code or the material code

MODELS	E27	LED 13W 3000K warm white	CORNER PLATES
1	130 001 ...	130 002 ...	
2	130 003 ...	130 004 ...	
3	130 005 ...	130 006 ...	147 003 ...
4	130 007 ...	130 008 ...	147 001 ...
5	130 009 ...	130 010 ...	
6	130 011 ...	130 012 ...	
7	130 013 ...	130 014 ...	
8	130 015 ...	130 016 ...	
9	130 017 ...	130 018 ...	
SPARE DIFFUSERS			
165 034 609			
165 033 609 (model 2)			

COLOURS CODES

Replace ... with the colour code

	RAL 9005 JET BLACK	000
	OLD RUSTIC	046
	GREEN PATINA	008
	GOLD PATINA	009

Other colours on request

MATERIAL CODE

Replace ... with the material code

	TINTED LACQUERED BRASS	070
--	------------------------	-----

With Aluminium base Jet black colour 000 (RAL 9005)

MOUNTING

Wiring entry points in grey
Fixing kit included (except models 6, 7)
Anchor bolts on request (models 6, 7) p.306

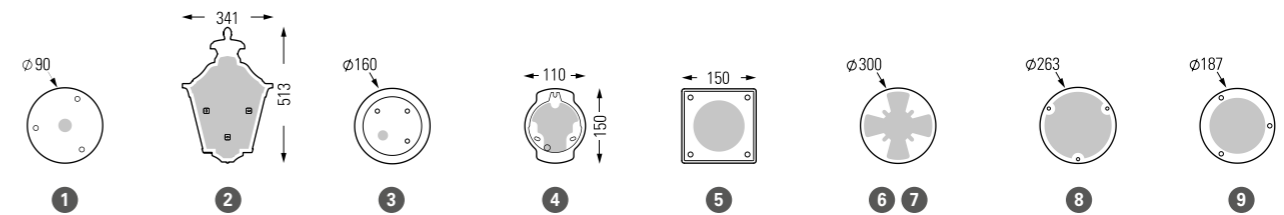

Citadelle



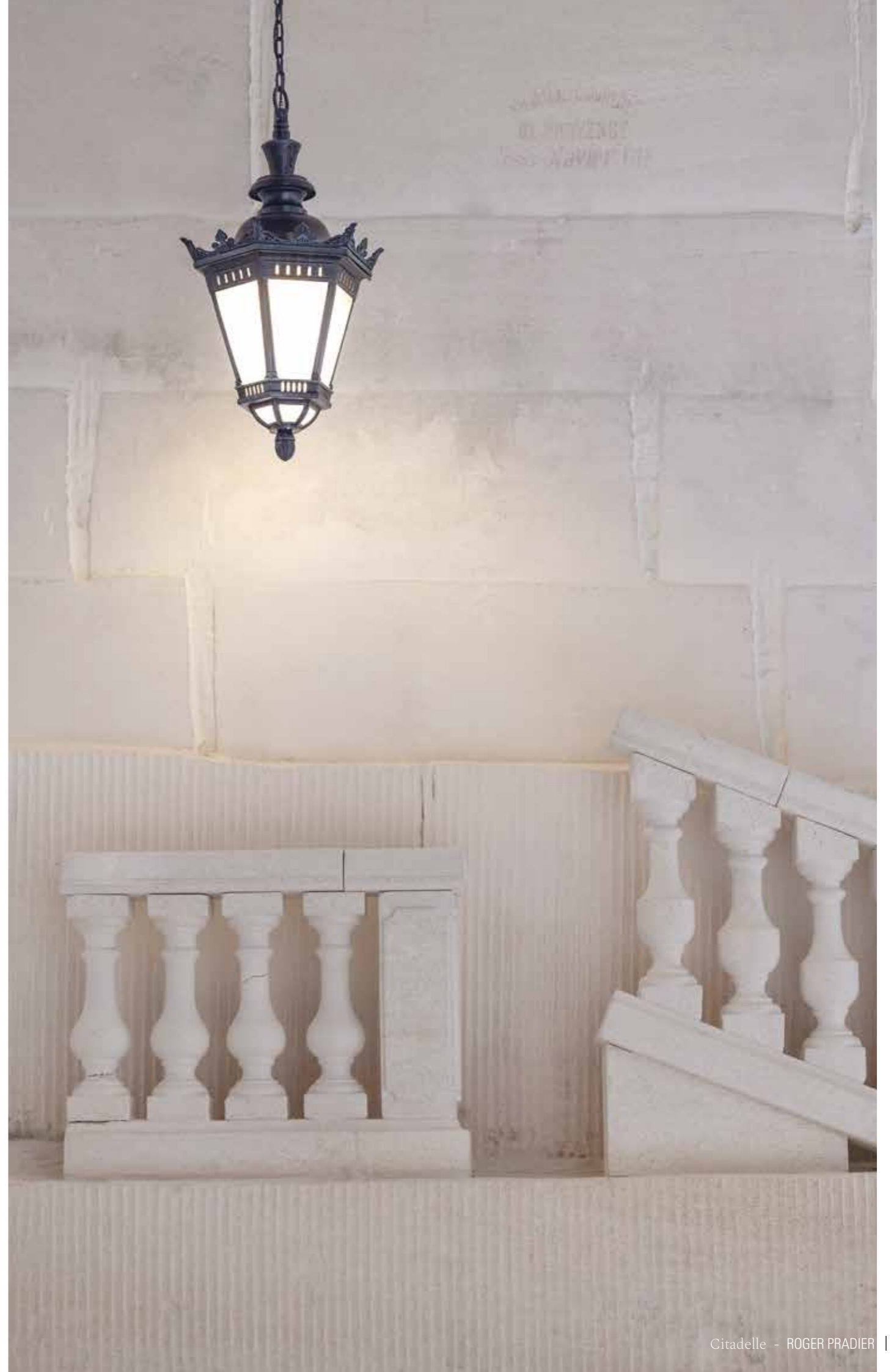

Citadelle

Aluminium - Patinated copper (unvarnished)
Opal PMMA diffuser
IP66 (lantern) / Class 1

SOURCES

LED 35W - 3000K warm white - IP65 LED module
LED 35W - 4000K neutral white - IP65 LED module
LED 70W - 3000K warm white - IP65 LED module
LED 70W - 4000K neutral white - IP65 LED module
E27 - 105W max H 280 mm max

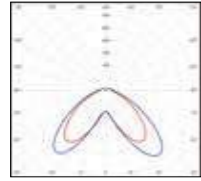

LED 35W
Real light output - 2027 lm
CRI > 80

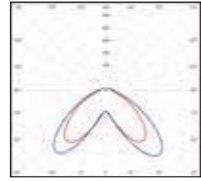

LED 70W
Real light output - 4482 lm
CRI > 80

PRM Eav 20 lux p.304
Model 3

LED 35W	Pathway	Spacing
H 3,50m	3,50m	10,00m

PRM Eav 20 lux p.304
Model 5

LED 70W	Pathway	Spacing
H 4,20m	4,50m	15,00m

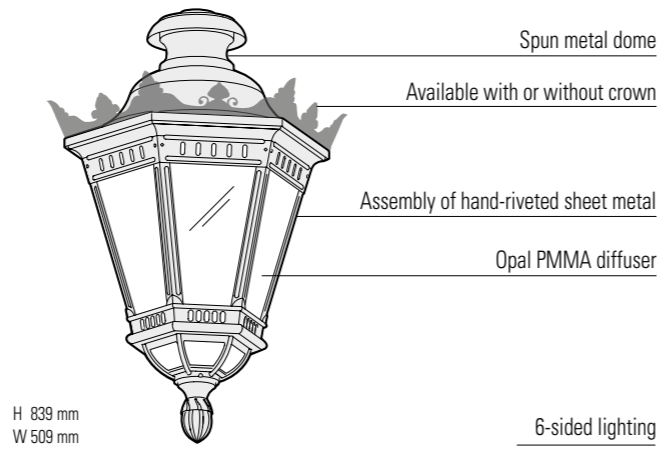

MODELS



H 1468 . W 509
1



H 1294 . W 509 . D 805
2



H 1397 . W 509 . D 914
3



H 1083 . W 509
4

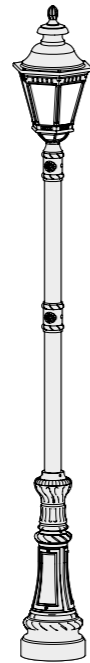

H 4178 . W 509
5

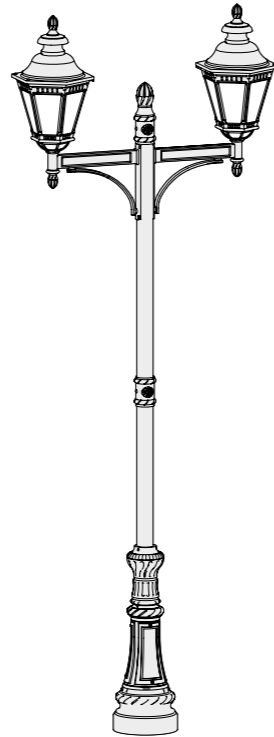

H 4411 . W 1703 . D 509
7



* 1 3 : bichromated steel support

Citadelle

REFERENCES

Replace ... with the colour code or the material code

Without crown

MODELS	E27	LED 35W 3000K warm white	LED 35W 4000K neutral white	LED 70W 3000K warm white	LED 70W 4000K neutral white
1	116 001 ...	116 003 ...	116 005 ...	116 007 ...	116 009 ...
2	116 011 ...	116 013 ...	116 015 ...	116 017 ...	116 019 ...
3	116 021 ...	116 023 ...	116 025 ...	116 027 ...	116 029 ...
4	116 051 ...	116 053 ...	116 055 ...	116 057 ...	116 059 ...
5	116 031 ...	116 033 ...	116 035 ...	116 037 ...	116 039 ...
7	116 041 ...	116 043 ...	116 045 ...	116 047 ...	116 049 ...

With crown

MODELS	E27	LED 35W 3000K warm white	LED 35W 4000K neutral white	LED 70W 3000K warm white	LED 70W 4000K neutral white
1	116 002 ...	116 004 ...	116 006 ...	116 008 ...	116 010 ...
2	116 012 ...	116 014 ...	116 016 ...	116 018 ...	116 020 ...
3	116 022 ...	116 024 ...	116 026 ...	116 028 ...	116 030 ...
4	116 052 ...	116 054 ...	116 056 ...	116 058 ...	116 060 ...
5	116 032 ...	116 034 ...	116 036 ...	116 038 ...	116 040 ...
7	116 042 ...	116 044 ...	116 046 ...	116 048 ...	116 050 ...

SPARE DIFFUSERS

165 020 606 (models 1 and 3)

165 021 606

COLOURS CODES

Replace ... with the colour code

	RAL 9005 JET BLACK	000
	GREEN PATINA	008
	GOLD PATINA	009

Other colours on request

MATERIAL CODE

Replace ... with the material code

	PATINATED COPPER (UNVARNISHED)	083
--	--------------------------------	-----

With Aluminium base Jet black colour 000 (RAL 9005)

MOUNTING

Wiring entry points in grey

Fixing kit not included

Anchor bolts on request (models 4, 5, 7) p.306

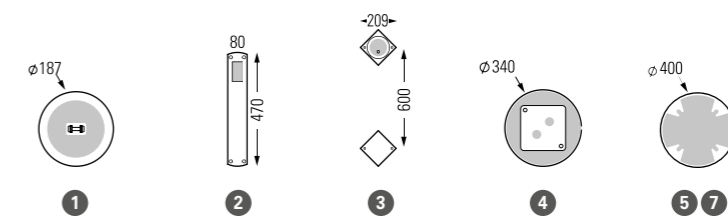

Technical Specifications

Size of lanterns

4 sided p.294
6 sided p.296

Wall lights with motion and photosensor

p.298

Bollards with motion and photosensor

p.299

Bollards with IP55 socket

p.300

Bornéo: electrical sockets / motion and photosensor

p.302

Commitment against light pollution Compliance with PRM Standards

p.304

Accessories

p.306

Ingress Protection (IP) ratings

p.308

Glossary

p.309

Information

p.309

Colour chart

p.312

Size of lanterns

4 sided lanterns

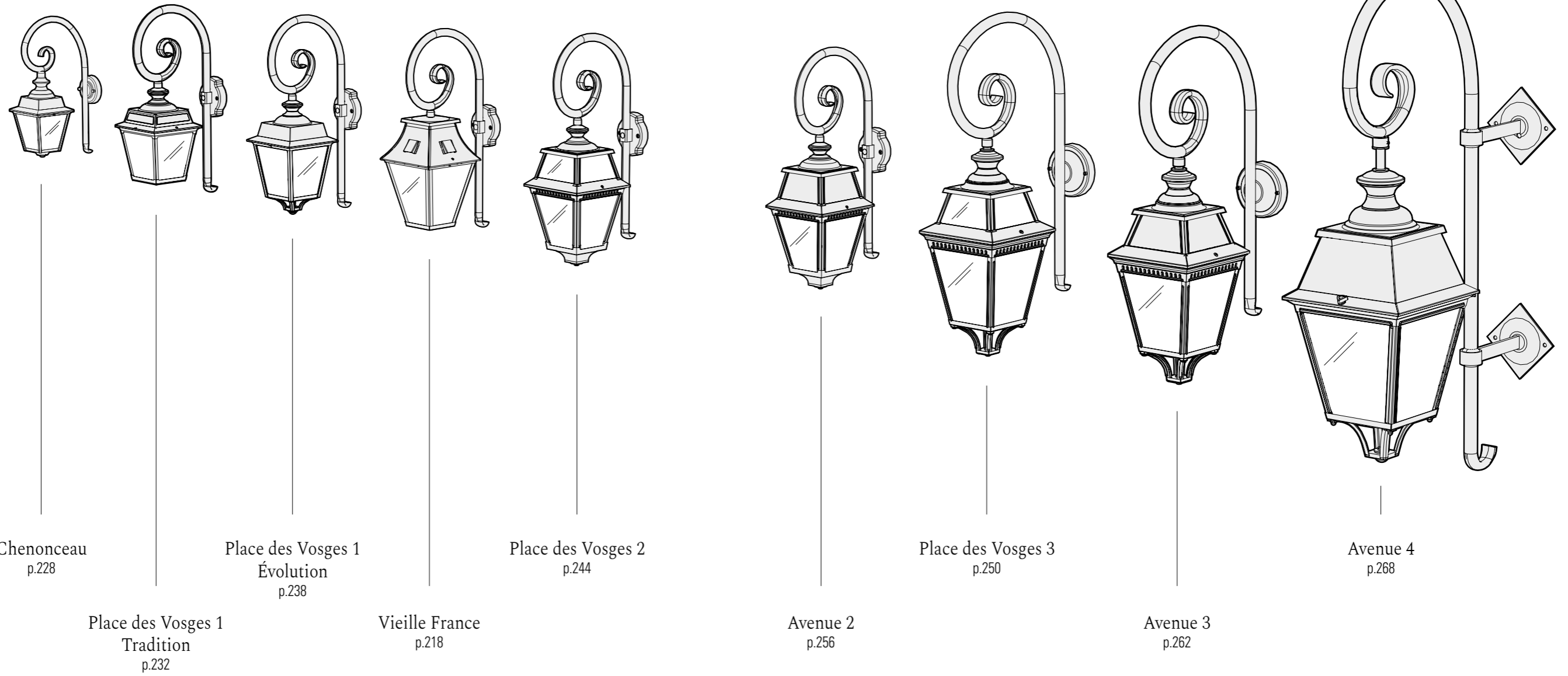

Size of lanterns

6 sided lanterns

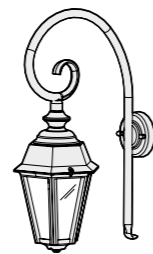

Monaco
p.202

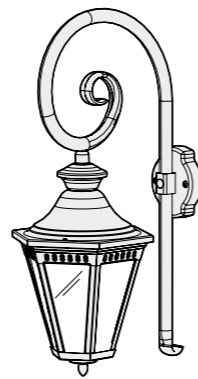

Victoria
p.274

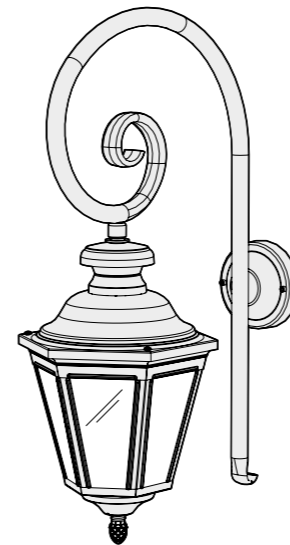

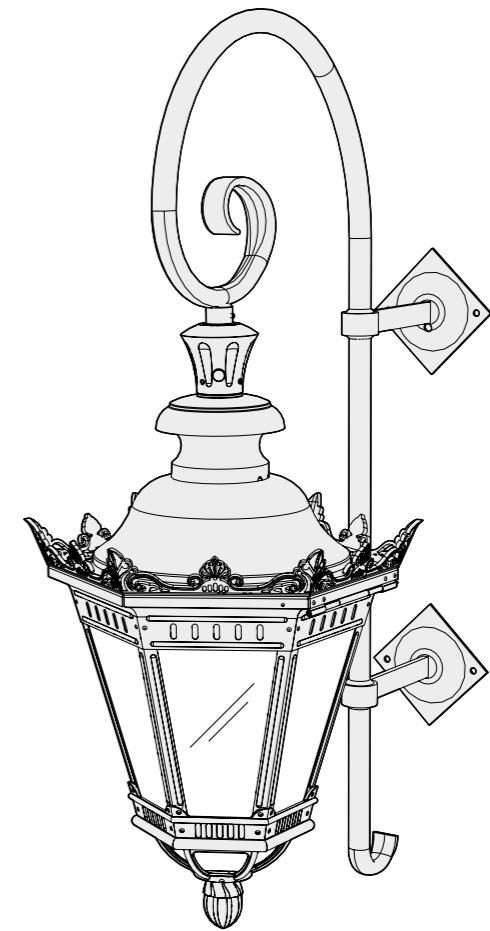

Louis XIII
p.280

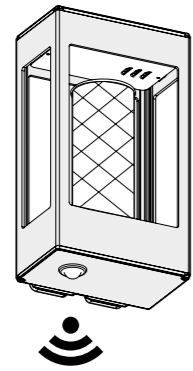

Citadelle
p.286

Wall lights with motion and photosensor



- Recommended mounting height 2,50 m
- Maximum range: 5 m
- Available settings via remote control
- Switch on time: from 15s to 30min
- Trigger threshold: 20 lux to 1000 lux
- Sensitivity
- Forced operation
- Supplied remote control 

Exclusively on these models

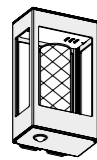

Tetra
p.32

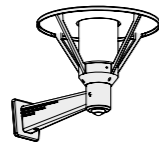

Bermude
p.140

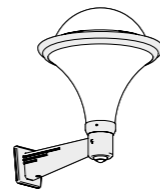

Dallas
p.178

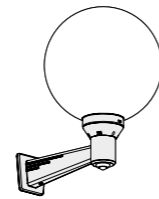

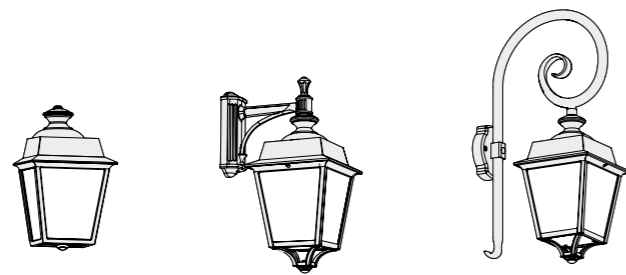

Moon
p.188

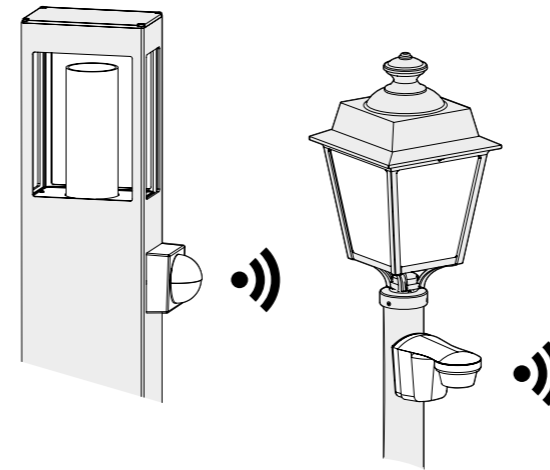

Place des Vosges 1 Evolution
p.238

Bollards with motion and photosensor



- Maximum range: 5 m
- Manual settings
- Switch on time:
1 s to 20 min (except Brick² and Tetra) - 2 s to 30 min (only Brick² and Tetra)
- Trigger threshold:
5 lux to 1 000 lux (except Brick² and Tetra) - 2 lux to 200 lux (only Brick² and Tetra)
- Adjustable sensitivity
- Maximum power per detector for several fixtures:
- up to 100 W LED - 150W FLC - 2 300W hal (except Brick² and Tetra)
- up to 500 W LED - 500W FLC - 2 300W hal (only Brick² and Tetra)
- White block detection for white products
Black block detection for other colors
- Removable motion and photosensor 

Exclusively on these models



Brick²
p.38

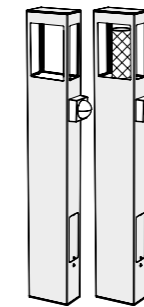

Tetra
p.32

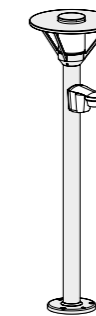

Bermude
p.140

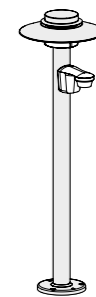

Kerlouan
p.148

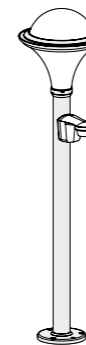

Dallas
p.178

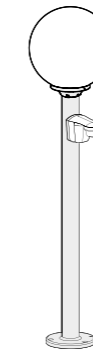

Moon
p.188

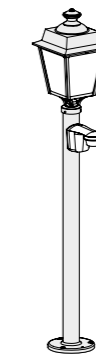

Place des Vosges 1 Evolution
p.238

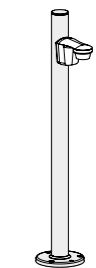

Bornéo
p.303

Bollards with IP55 socket

Country-specific sockets
Separate power supply: socket/light

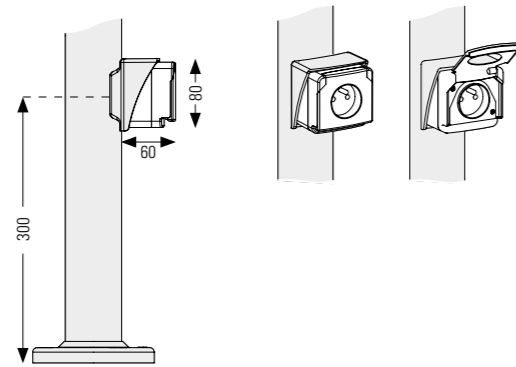

Exclusively on these models



Brick²
p.38

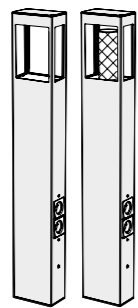

Tetra
p.32

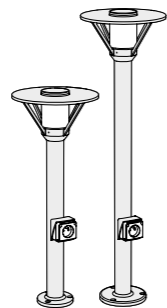

Bermude
p.140

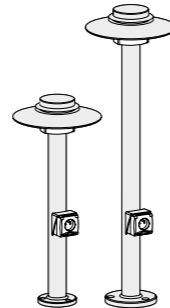

Kerlouan
p.148

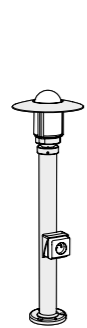

Newpark
p.164

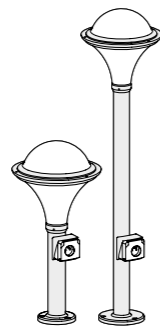

Dallas
p.178

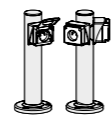

Bornéo
p.302





Bornéo

Electrical sockets / motion and photosensor

Aluminium
IP44 / Class 1 - IP55 socket

MODELS

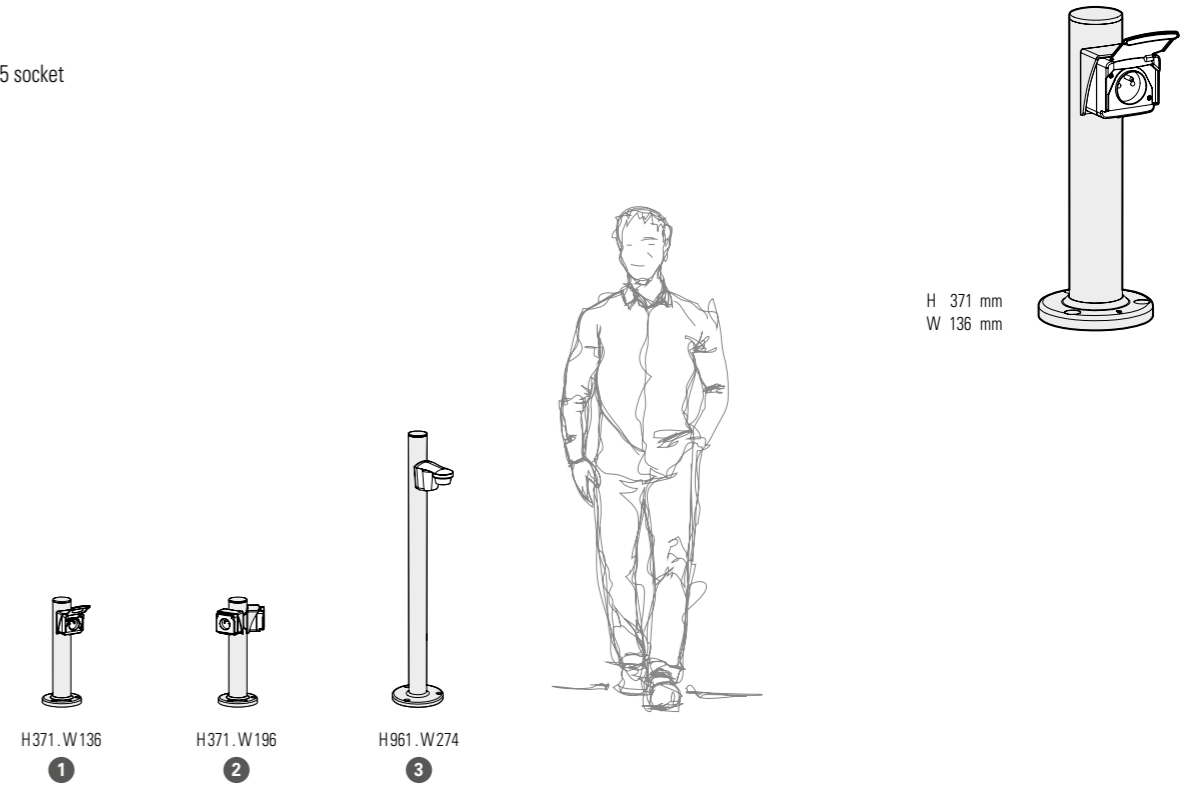

REFERENCES

Replace ... with the colour code

MODELS	FRENCH SOCKET	SCHUKO SOCKET Type F	SWISS SOCKET Type J	SENSOR
1	107 001 ...	107 002 ...	107 004 ...	
2	107 006 ...	107 007 ...	107 009 ...	
3				107 011 ...

COLOURS CODES

Replace ... with the colour code

	DARK GREY 006		OLD RUSTIC 046
	SLATE GREY 059		SANDSTONE 054
	METAL GREY 023		RAL 6009 BRITISH GREEN 019
	WHITE 001		RAL 6009 FIR GREEN 067
Other colours on request			RAL 5011 STEEL BLUE 065

MOUNTING

Wiring entry points in grey
Fixing kit included

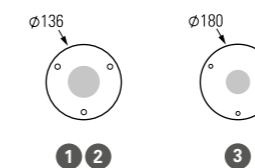

Commitment against light pollution

Roger Pradier® is committed to complying with the new regulations against light pollution. In France in particular, the Decree of 27 December 2018 on the prevention, reduction and limitation of light pollution regulates lighting practices. Since 1 January 2020, these provisions apply to «light installations» in order to be consistent with today's environmental issues.



Colour temperature < 3000K
ULOR < 1

Compliance with PRM Standards (Person with Reduced Mobility)

Any external path must be structured in such a way as to allow any user, and in particular persons with reduced mobility (PRM), access to the entrance of an establishment open to the public. For this path to be accessible, taking into account the transition zones, its horizontal mean illumination level (Eav) to be maintained at ground level over its entire length must respect 20 lux average (according to the legislation of each country).

Many Roger Pradier® luminaires make it possible to meet PRM requirements. They can be identified in the pages of this catalogue by the presence of a PRM table. Some collections, such as Tetra and Hector, offer special performance thanks to the Asymmetrical LED technology that allows spacing of up to 12 m for bollards and 25 m for poles, while respecting the Eav = 20 lux.

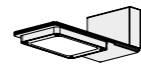

Hector Asymmetric p.26

PRM Eav 20 lux

LED ASYM 35W	Pathway	Spacing
H 3,00 m	3,00 m	25,00 m

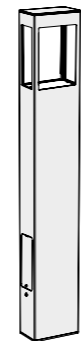

Tetra Asymmetric p.32

PRM Eav 20 lux

LED ASYM 12W	Pathway	Spacing
H 1,10 m	2,00 m	12,00 m



Accessories

IP68 waterproof connector box

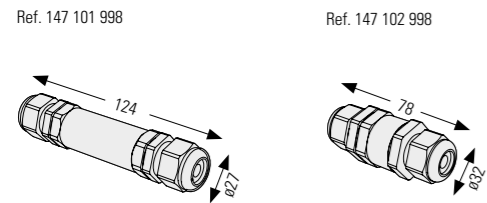

IP68 waterproof connector box (1-in 2-out)

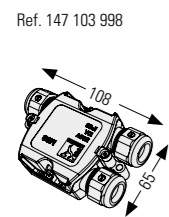

Lamp FLC 2Gx13

Exclusively for the Mona collection

FLC 22W Ref. 147 106 998



Frosted PMMA Bulb cover

Exclusively for the Tetra collection

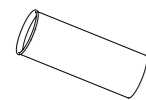

Ref. 165 075 606



Anchor bolts on request

COLLECTIONS	N° MODELS	REFERENCES
HECTOR	2, 3	147 108 998
TETRA	5	147 110 998
QL33	6, 7	147 108 998
AVENUE 2	11	147 109 998
AVENUE 3	7, 8, 9	147 109 998
	10, 11	147 108 998
AVENUE 4	6	147 110 998
	8, 9	147 111 998
LOUIS XIII	6, 7	147 109 998
CITADELLE	4	147 110 998
	5, 7	147 111 998
LOUVRE	10, 11	147 109 998
PLACE DES VOSGES 2	11	147 109 998
PLACE DES VOSGES 3	7, 8, 10	147 109 998
LAMPIOK 2	4, 5	147 108 998
LAMPIOK 4	3, 4, 5, 6	147 111 998

Globes

MODELS	OPAL PMMA GLOBES	SMOKED PMMA GLOBE
 <p>Diameter 200 mm Ø Int.: 76 mm Ø Ext.: 82 mm With thread 60W max.</p>	165 015 606	165 015 607
 <p>Diameter 300 mm Ø Int.: 112 mm Ø Ext.: 139 mm With bayonet system 100W max.</p>	165 016 606	

Accessories

Corner plates

MODELS

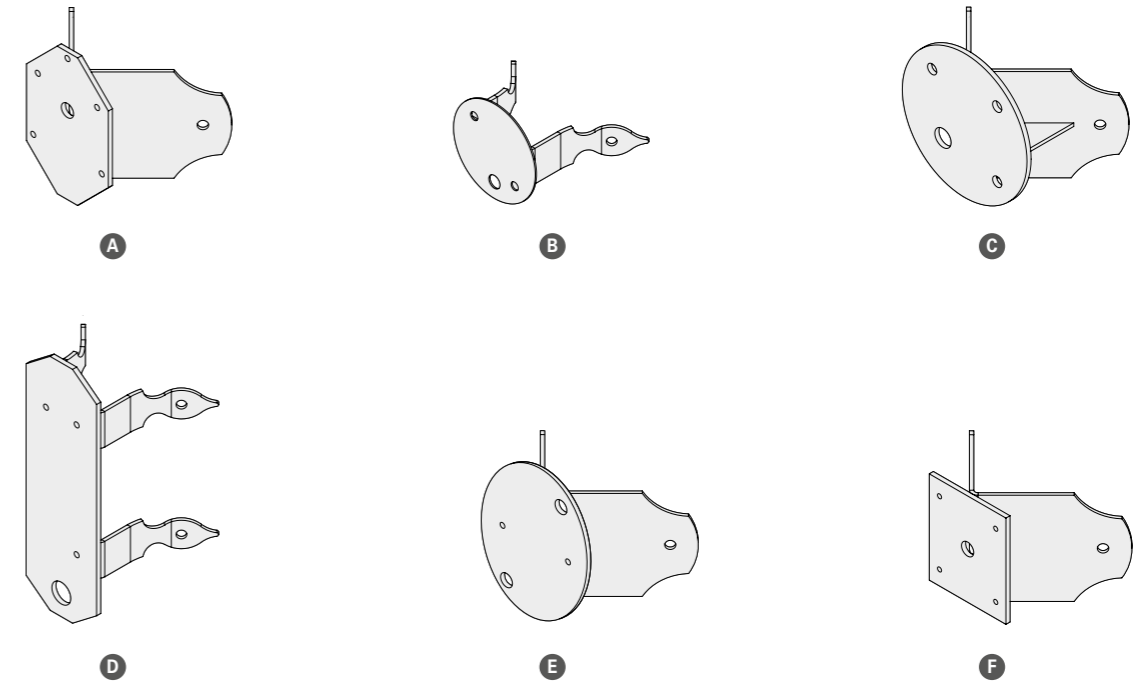

















REFERENCES

Replace ... with the colour code

MODELS	A	B	C	D	E	F
	147 001 ...	147 002 ...	147 003 ...	147 004 ...	147 005 ...	147 006 ...

COLOURS CODES



Replace ... with the colour code

	RAL 9005 JET BLACK 000		RAL 5009 MATTE AZURE BLUE 134
	SLATE GREY 059		BLUE 111
	DARK GREY 006		WHITE 001
	OLD RUSTIC 046		RAL 3005 WINE RED 066
	SANDSTONE 054		RAL 6009 BRITISH GREEN 019
	LIMESTONE 053		RAL 6025 FERN GREEN 109
	METAL GREY 023		GREEN PATINA 008
	RAL 7044 SILK GREY 105		GOLD PATINA 009
	RAL 5011 STEEL BLUE 065	Other colours on request	





Ingress Protection (IP) ratings

The degrees of protection (IP) are defined by the french standard NF EN 60-529

IP **X**_: protection rating against solids

- IP **0**_ No protection
- IP **1**_ Protected against solid foreign objects over 50 mm in diameter (e.g. involuntary contact with the hand)
- IP **2**_ Protected against solid foreign objects over 12 mm in diameter (e.g. finger)
- IP **3**_ Protected against solid foreign objects over 2,5 mm in diameter (e.g. tools and wires)
- IP **4**_ Protected against solid foreign objects over 1 mm in diameter (e.g. small tools and wires)
- IP **5**_  Dust-protected (no harmful deposits)
- IP **6**_  Totally protected against dust

IP **_X**: protection rating against liquids

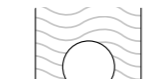
- IP **_0** No protection
- IP **_1** Protected against vertically dripping water (e.g. condensation)
- IP **_2** Protected against dripping water up to 15° from vertical
- IP **_3** Protected against direct spray of water up to 60° from vertical
- IP **_4**  Protected against direct spray of water from all directions
- IP **_5**  Protected against jet of water from all directions applied by spray lance
- IP **_6**  Protected against direct sprays of water comparable to big waves
- IP **_7**  Protected against the effects of immersion
- IP **_8**  Protected against long periods of immersion under pressure

Glossary

«Boomerang»: wall mounting plate

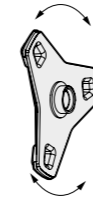

Can be easily and quickly fixed to any surface.
Allows pre-mounting.
Isolates the aluminium casing from the wall.
Wall light can easily be rotated and locked in place.

«Easycap»: waterproof quick-connect system



«Easycap» is a patented membrane that allows wires to be directly connected.

Solid-core wires can be directly pushed through the membrane.
For stranded wires, the installer must crimp cable terminals first.

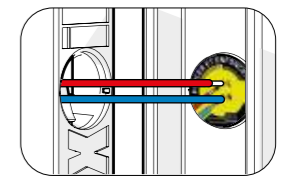

Information

Each reference is a complete product.

Bulbs are not included.

All standard Roger Pradier®'s electrical plugs are Schuko type F (mobile models).

Models in brass or copper are provided with black aluminium supports.

The steel supports are not covered by the anti-corrosion warranty.

The coating of brass, copper, zinc, stainless steel, galvanized or enamelled steel models can deteriorate depending on the climate or the environment. These materials are not guaranteed against oxidation.

It is recommended to regularly maintain the light fixtures in accordance with the practices of the profession and to prohibit the use of any abrasive or corrosive material or product.

Our terms of sale are listed on the back of our delivery notes and bills.

As part of its constant strive to improve the quality of the light fixtures, Roger Pradier® reserves the right to modify, without notice or compensation, all or part of the equipment presented in this catalogue.

The images, dimensions and scenarios in the photographs in this catalogue cannot be regarded as contractual.

Acknowledgements

We would like to thank those who allowed us to photograph our lights by opening their doors to us:

- Anne de Varennes, Abbaye de Varennes (36)
- Monsieur et Madame Vincent Breugelmans
- Centre National de Tir Sportif, Déols (36)
- Cercle Nautique du Cap-Ferret (33)
- Chez Boulan, Lège-Cap-Ferret (33)
- Monsieur et Madame Lucien Giraud
- Monsieur et Madame Pierre-François Grandjean
- Jean-Marc de Pas, Le Jardin des Sculptures, Château de Bois-Guilbert (76)
- La Cabane Whitehe, Cap Ferret (33)
- Les Jardins de Poulaines (36)
- Le Rize - Centre Mémoires et Société, Villeurbanne (69)
- Monique Barge Architecte, Châteauroux (36)
- Monsieur Jean-François Piaulet
- Monsieur Jean-Luc Tamenti, Carrière Sarragan (13)
- Monsieur et Madame Simon Verspreuwen

A big thank you also to the City of Châteauroux who allowed us to photograph our light fixtures around the new swimming pool, on the skatepark and pumptrack. Thank you to all those who participated to the game of silhouettes and in particular Alexis, Alrick, Félix, Joulianne, Jules, Miguel, Théo and You. Thanks to Stéphane Joyeux for all the drawings of the team and to all those who worked on the production of this catalogue.

Photo credits

- © Arnaud Childéric - Kalice photographies
- © Dimitri Coste
- © Image de Marc
- © Camillegarra
- © Grabuge.co

Graphic design and production

Roger Pradier® - Atelier Laete

Legal deposite: December 2021
Printed in France by Centr'Imprim in Issoudun (36)

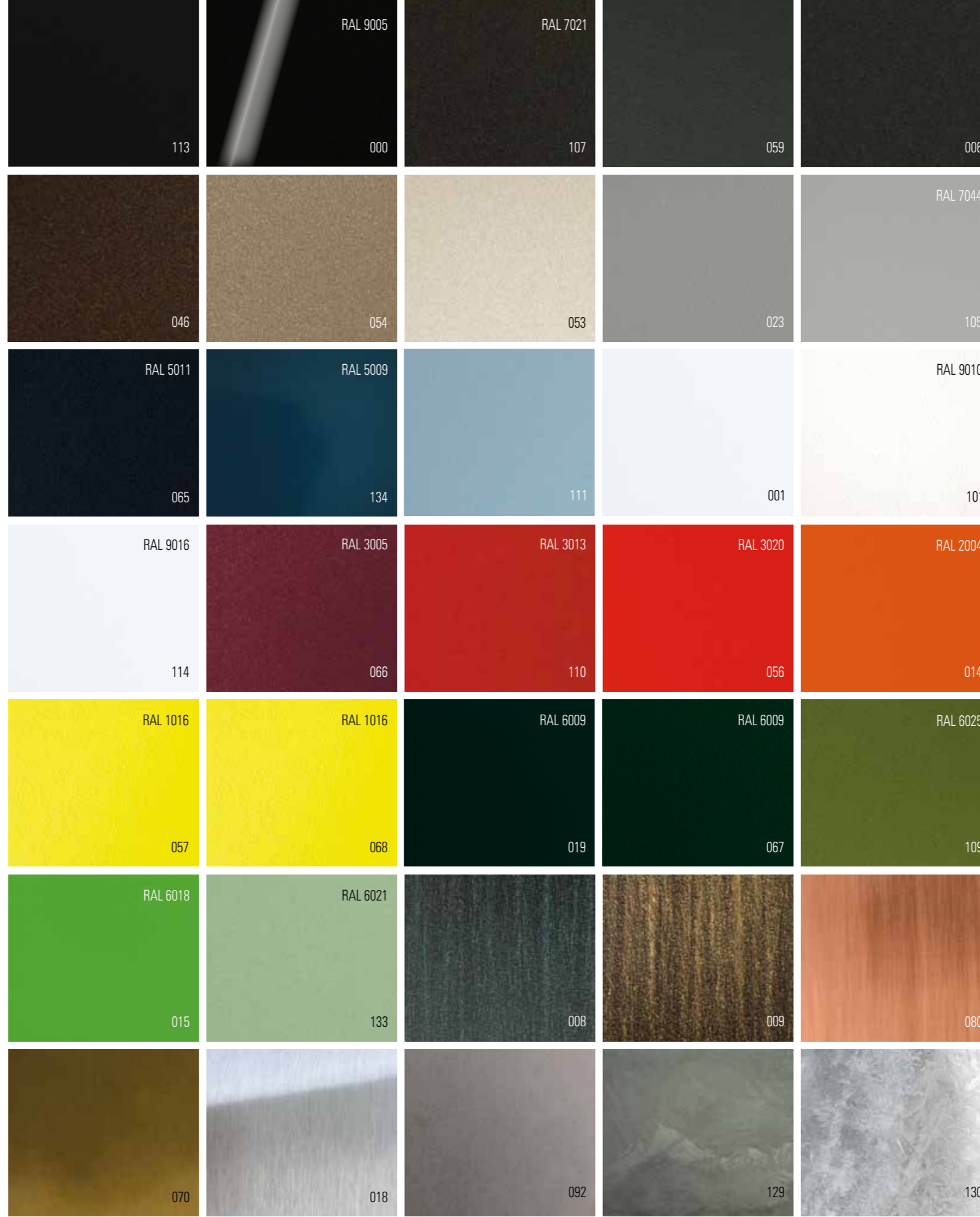

Colours

	VELVET BLACK	113
	RAL 9005 JET BLACK	000
	RAL 7021 BLACK GREY	107
	SLATE GREY	059
	DARK GREY	006
	OLD RUSTIC	046
	SANDSTONE	054
	LIMESTONE	053
	METAL GREY	023
	RAL 7044 SILK GREY	105
	RAL 5011 STEEL BLUE	065
	RAL 5009 MATTE AZURE BLUE	134
	BLUE	111
	WHITE	001
	RAL 9010 PURE WHITE	101
	RAL 9016* WHITE SIGNALISATION	114
	RAL 3005 WINE RED	066
	RAL 3013 TOMATO RED	110
	RAL 3020 TRAFFIC RED	056
	RAL 2004 PURE ORANGE	014
	RAL 1016 * SULFUR YELLOW BRILLANT	057
	RAL 1016 SULFUR YELLOW	068
	RAL 6009 BRITISH GREEN	019
	RAL 6009 FIR GREEN	067
	RAL 6025 FERN GREEN	109
	RAL 6018 YELLOW GREEN	015
	RAL 6021 PALE GREEN	133

Patinas

	GREEN PATINA	008
	GOLD PATINA	009

Materials

	PATINATED LACQUERED COPPER	080
	TINTED LACQUERED BRASS	070
	STAINLESS STEEL	018
	RAW ZINC	092
	**RAW ALUMINIUM - MATT VARNISH	129
	* GALVANISED STEEL	130
	* WHITE ENAMELLED STEEL	131
	* BLACK ENAMELLED STEEL	132

* Only for Cooper / ** Only for Brick² model 1

Colours and finishes shown in this catalogue are merely indicative due to printing processes. Please refer to our real colourswatches for a more realistic rendering.

OR LIGHTING
1910
FRANCE
SAUROUX

ROGER PRADIER

France +33(0)2 54 53 56 54

International +33(0)2 54 53 56 56

Fax +33(0)2 54 34 78 45

info@roger-pradier.com

roger-pradier.com

Factory - Headquarters

46 avenue d'Occitanie
36250 Saint-Maur - France

Trade office Paris

12 rue Lamartine
75009 Paris - France

